

# VIBRATION ASSESSMENT OF VARIABLE SPEED VERTICALLY MOUNTED PUMPS

by

**Thomas J. Walter**

Manager, Mechanical Engineering  
Mechanical Technology Incorporated  
Latham, New York

and

**Shalom Zelingher**

Manager, Electrical and Mechanical Research and Development  
New York Power Authority  
New York, New York



*Thomas J. Walter is Manager of Mechanical Engineering for the Shaker Research Division of Mechanical Technology, Incorporated (MTI). He joined MTI in 1977, and is responsible for marketing, financial, and technical efforts involving field troubleshooting and periodic vibration monitoring of machinery systems, including onsite acquisition, analysis, and diagnosis of data to determine machinery problems.*

*In previous positions at MTI, Mr. Walter was Manager of various engineering sections where efforts involved development and application of high speed balancing methods and techniques to diagnose vibration problems in vertically mounted pumps. As Project Engineer, he maintained responsibility of contracts involving vibration and balancing. Prior to joining MTI, he was a test engineer at Newport News Shipbuilding, where he was involved in noise and vibration reduction efforts relating to U. S. Navy submarines and surface ships.*

*Mr. Walter received his B. S. in Mechanical Engineering from the University of Dayton, and an M.B.A. from the College of William and Mary. He has authored many technical reports and has published several papers for seminars and workshops, including roles as lecturer and discussion group leader at prior Pump Users Symposia.*



*Shalom Zelingher was born in Romania. He received his B. S. degree and his M. S. degree from the Polytechnic Institute of New York.*

*From 1976 to 1983, he was an Electrical Engineer with the Electrical Generation Section of the American Electric Service Corporation, where he participated in the design and engineering of large power plants. In 1983, he joined the New York Power Authority as an Electrical Engineer in the Research and Development Division. His responsibilities include the development and transfer of new technologies to improve predictive and performance monitoring of electrical and mechanical apparatus in substations and power plants, and the investigation and evaluation of new transmission techniques to meet long distance bulk power transfer requirements.*

*Mr. Zelingher is a member of the IEEE Power Engineering and Industry Applications Societies, and the Station Control Subcommittee of the Power Generation Committee. He is also an industry advisor on the on the EPRI Fossil Fuel Power Plants Task Force and a member of ESEERCO's Electrical Systems and Equipment Committee. He is the co-author of several technical papers.*

## ABSTRACT

Analytical and experimental assessments of the vibration characteristics are described for two 700 hp, vertically mounted centrifugal service water pumps following their conversion from fixed speed to variable speed operation. This work was accomplished by the New York Power Authority at the Charles Poletti Power Project in Queens, New York. Implementation criteria and a description of the adjustable speed drive system are presented, as are predicted and measured dynamic performance of the modified pumps during startup and initial operation.

## BACKGROUND

The Charles Poletti Power Project was designed and constructed as an oil/gas fired 865 MW base load plant. Since its initial operation in 1975, this plant has been cycling during week-

days between 150 MW and 865 MW. On weekends, the plant typically operates at 150 MW.

In general, auxiliary equipment in a base load plant is designed for, and has its peak mechanical and electrical efficiency at, maximum plant output. As a result, the auxiliaries consume disproportionately more power at reduced plant output.

The service water pumps supply East River brackish water to the plant's service water system. Only one pump operates at a time while the other is used as a backup. Each pump is rated 15,000 gpm, 70 psi, 1190 rpm, and is driven by a 6-pole squirrel cage induction motor. However, at reduced power plant load levels and/or cool river water temperatures (which varies from 30°F to 75°F), flows of only 5,000 gpm are sometimes required.

To mitigate erosion and overpressurization problems caused by throttling the flow with control valves, and to reduce auxiliary power consumption at reduced plant loads, the utility elected to backfit both pumps with adjustable speed drives (ASD). This approach was chosen because the capital investment for this

equipment conversion could be returned by energy savings within approximately five years. It could also provide a learning experience to implement this type of conversion on other plant equipment.

In early 1988, each of the two service water pumps was converted from fixed speed to variable speed operation by using two, six-channel thyristor/gate turn off (GTO) water cooled ASD units. As shown in Figure 1, each ASD package consists of input and output dry-type transformers, packaged ASD power electronics, controls, protection and diagnostics and a skid mounted housing unit. Prior to the ASD retrofit, the pumps were modified at the recommendation of the pump manufacturer by adding two additional shaft bearings and reducing upper shaft diameter to prevent shaft lateral and torsional critical speeds from occurring within the pump's running speed range.

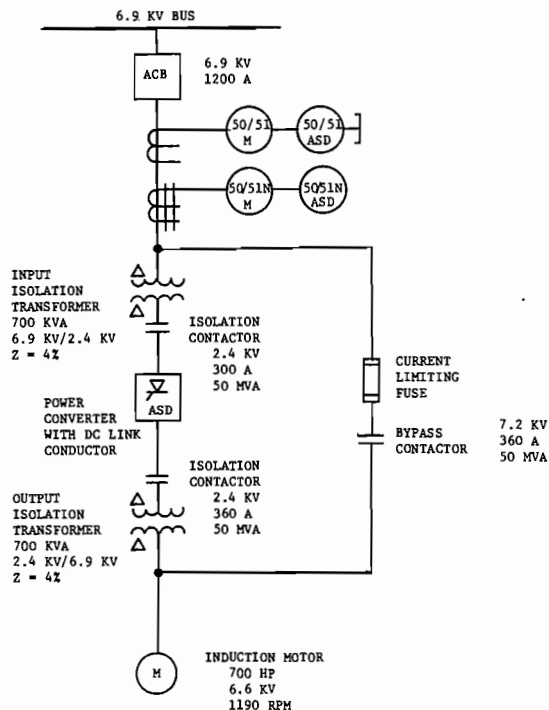

Figure 1. Typical Service Water Pump ASD One Line Diagram.

Except for some initial difficulties with entrained air in the ASD electronics cooling system, fuses that were too small to handle transformer in-rush current and electronic noise in the speed control circuitry, no significant ASD electronic problems have been encountered. O'Donnell describes in more detail the justifying criteria for installing the ASD system, and lessons learned during the installation and startup [1]. The remainder of this discussion is focused on the vibration aspects of the pumps' performance since conversion to ASD operation.

#### PREDICTED ROTORDYNAMIC PERFORMANCE

To verify the vendor's analytical predictions and to ensure that the pumps would not be subjected to dangerous vibrations, the utility undertook an independent effort to assess the vibration performance of the modified pumps.

To assess the probable effects of running the pumps at speeds varying from 700 to 1200 rpm, two different mathematical models of the pumps were constructed—one for the lateral analysis and one for the torsional analysis. The purpose of the lateral

analysis was to evaluate the pumps for damped and undamped critical speeds and determine their sensitivity to destabilizing forces. The torsional model was developed to evaluate the potential for torsional vibration following the conversion to ASD operation.

#### Lateral Analysis Results

For the lateral analysis, the pump was modelled as two separate levels. The first level consisted of the motor shaft and rotor, the rotor/pump coupling, the pump shaft, and the pump impellers. The second level consisted of the motor casing and stator, discharge elbow, and the entire pump column. These two levels were analytically connected to each other via bearings, and the entire structure was connected to ground via the discharge elbow base. A typical vertical pump and associated modelling stations are shown in Figure 2.

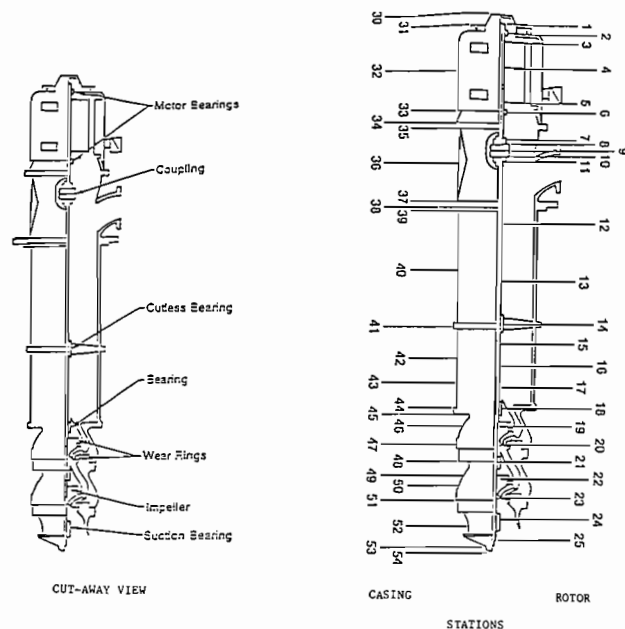

Figure 2. Typical Modelling Stations for a Vertical Pump.

The lateral model was developed and run using the finite element analysis tool for utility rotordynamic evaluation (FEATURE). This computer program performs linear critical speed, damped response, and stability calculations for a wide range of rotor geometries, including multiple, concentric, counter-rotating spools, and large, multispan, rigidly coupled rotors. A finite element formulation gives the program numerical stability. This computer code developed by the Electric Power Research Institute (EPRI) [2]. The analysis of the service water pumps was conducted using guidelines established by EPRI specifically for modelling vertically mounted pumps [3].

In general, a computer model is developed by first defining the appropriate material properties used in the pump. These properties include the modulus of elasticity, density, shear modulus and Poisson's ratio. Each set of properties is assigned a material number, for later reference by each segment of the model.

The pump/motor combination is then divided into levels. For a vertical pump, this typically includes separate levels for the rotating elements, the bowls and casings, and the outer enclosing tube, if present. A series of locations are then selected along the length of each level of the model. These locations divide the

level into elements of finite length. These locations, or stations, are typically chosen at:

- The ends of the model.
- Area of significant changes in cross section. In vertical pumps, this is usually at all inline couplings, impellers, collars/sleeves, motor shaft windings, and the coupling between the motor and pump.
- Bearing and wear ring locations.
- Locations of likely forcing functions. This typically includes the motor rotor, impellers and the coupling.
- Areas of changes in material properties.

The next step is to construct a tabulation which accurately represents the rotor geometry and bearing coefficients. Each element that has been identified must be represented by eight parameters: mass (lumped at one end of the element), polar moment of inertia of the mass, station length, mass diameter, diameter of the effective stiffness of the mass, inner diameter, and material reference number.

"Bearing" coefficients need to be developed at each location the rotor is supported. This includes bearings, wear rings, flanges, interlevel supports, the sole plate and any other method of rotor support. If only undamped natural frequencies are of interest, only stiffness properties are needed. For response analyses and stability predictions, damping details are also required.

Manufacturer's catalogs generally contain the needed information for most types of fluid film and rolling element bearings. Computer programs are also available for both standard and nonstandard bearings [4]. However, "bearing" properties of wear rings and water lubricated bearings cannot be obtained from commonly available sources, as most do not account for axial pressure gradients across these devices. Accurate bearing and wear ring coefficients can be obtained by using a theory postulated by Black in the early 1970s, which computes dynamic coefficients both with and without the presence of an axial pressure gradient. Black [5] describes the approach, and a 1988 report [3] contains a computer program which applies this theory to models of vertical pumps.

Cutless, or water-lubricated shaft bearings, represent another challenge in modelling vertical pumps. To date, a rigorous approach for calculating stiffness and damping coefficients for cutless bearings has not been developed. However, order of magnitude stiffness approximations can be developed by using bearing deflection vs load information from the bearing manufacturer. Direct stiffness values can then be calculated. It should be noted, however, that other important factors such as bearing clearance, temperature and rotational frequency are not considered. Damping values can be approximated by applying a loss coefficient to the stiffness value and dividing it by the angular velocity. This procedure is also further explained in a 1988 report to the EPRI [3].

An initial step in the lateral analysis of the service water pumps was development of a critical speed map. The curves on Figure 3 show undamped critical speeds for the first nine modes predicted using typical support stiffnesses, which were varied from  $1 \times 10^3$  to  $1 \times 10^5$  pounds per inch. This type of plot is important to the dynamic analysis of a rotor-bearing system in that it shows the "dynamic regime" in which the system is operating. When the actual support stiffnesses curves are added to a critical speed map, points at which the curves intersect indicate the locations of the system's critical speeds. Large motions and forces may result at these speeds.

Critical speed maps can also be used to evaluate the effect of changes in bearings stiffness. The predicted critical speeds are presented in Figure 4 for four hypothetical cases which simulate

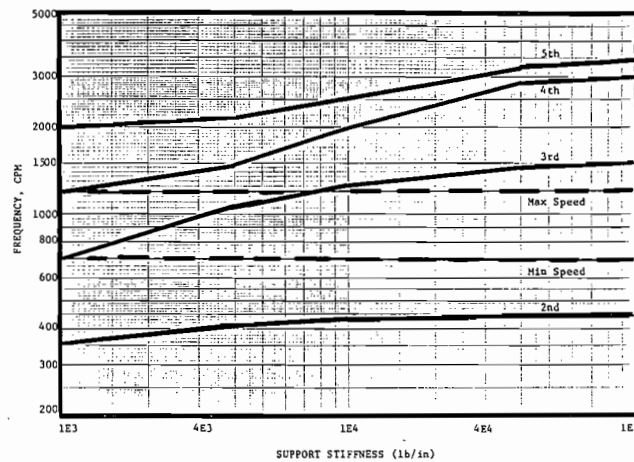

Figure 3. Critical Speed Map.

various pump configurations and conditions. The four conditions shown are as follows:

- Original pump, before modification to ASD operation
- Modified pump, with worn Cutless bearings and worn packing
- Modified pump, with new Cutless bearings and worn packing
- Modified pump, with new Cutless bearings and new packing

The addition of two bearings, either new or worn (configuration 2 or 3 as shown in Figure 4), significantly increases the third and fourth lateral modes of the pump.

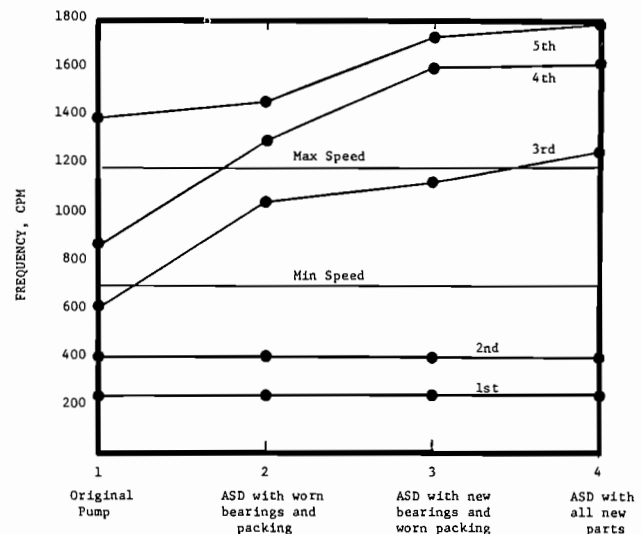

Figure 4. Predicted Critical Speeds for Various Pump Configuration.

In addition, when stiffness due to the stuffing boxes is considered (configuration 4), the third mode is moved above the operating range of the pump. As these items wear, however, their effective stiffnesses decrease. The result is that the modes may fall back into the operating speed range. As described below, the pumps are presently operating in a range that would place them in the configuration 3-4 region.

A lateral stability analysis concluded that the pump should remain dynamically stable throughout its operating speed range. For a newly installed pump (configuration 4), there are no pre-

dicted damped natural frequencies present in the operating range. Of interest, however, are the 1200 rpm logarithmic decrements (log decs) predicted for the first (3 Hz) and second (7.5 Hz) natural frequencies. The log dec is a unitless measure of stability (i.e., the difference in amplitude between subsequent shaft revolutions in response to an exciting force). Theoretically, a machine will be stable if the value of the log dec is greater than zero. This means that the observed amplitude decreases (decays) between successive shaft revolutions. Values above + 0.4 are generally in the "safe" range. Values greater than 1 represent "overdamped" modes, and generally are not detected in measured vibration. For values less than zero, the machine is likely to be unstable and increasing levels of vibration can result. At 1200 rpm, the predicted log dec for the first two modes were 0.012 and 0.12, respectively, which indicates a positive but marginal level of stability. Of particular concern is the second (7.5 Hz) mode which could become a "half-times" ( $1/2 \times$ ) frequency at pump speeds in the 900 rpm range. Response to both first and second natural frequencies has been observed in the vibration data.

#### Torsional Analyses Results

The torsional vibration model consisted of a series of concentrated masses connected by massless springs. Results of the analysis indicated two torsional modes of interest: one within the operating speed range at 1088 rpm and another slightly above the pump operating range at 1274 rpm. The mode shapes are presented in Figure 5. The third mode can be excited by normal amounts of synchronous force within the pump. The close proximity of the fourth mode to the maximum pump operating speed may result in some torsional response to full speed synchronous vibration. The inherently low level of damping usually found in torsional motion may further allow this mode to be excited.

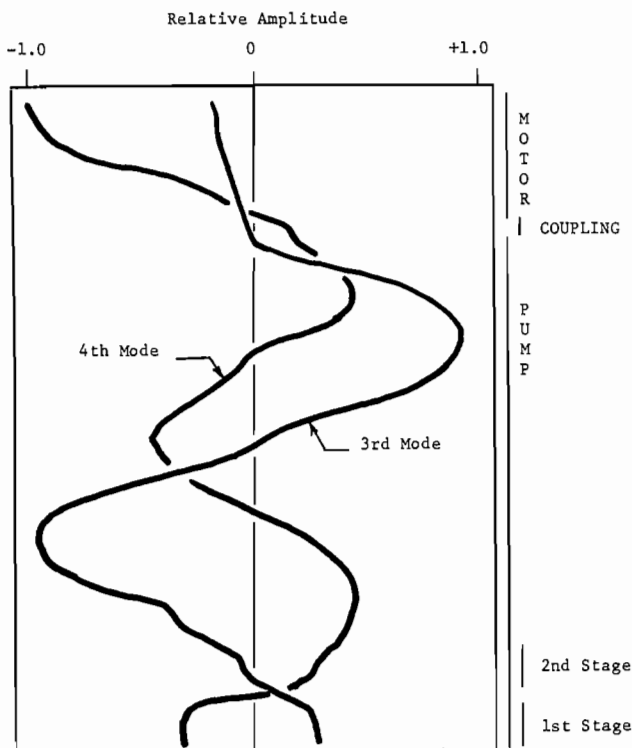

Figure 5. Predicted Torsional Mode Shapes.

#### INSTRUMENTATION

The vibration sensors selected to measure the operating performance of the pumps were based on the results of the rotor-dynamic analysis, past experience in vertical pump vibration monitoring, and accessibility constraints. Accessibility restrictions precluded use of submerged shaft displacement sensors. Displacement sensors were also ruled out because of concern over the debris in the system that would result from disintegration of a sensor. The sensor types and locations used to monitor the vibration performance of the service water pumps are shown in Figure 6. The sensors were installed over a six-month period as the pumps were taken off-line for maintenance.

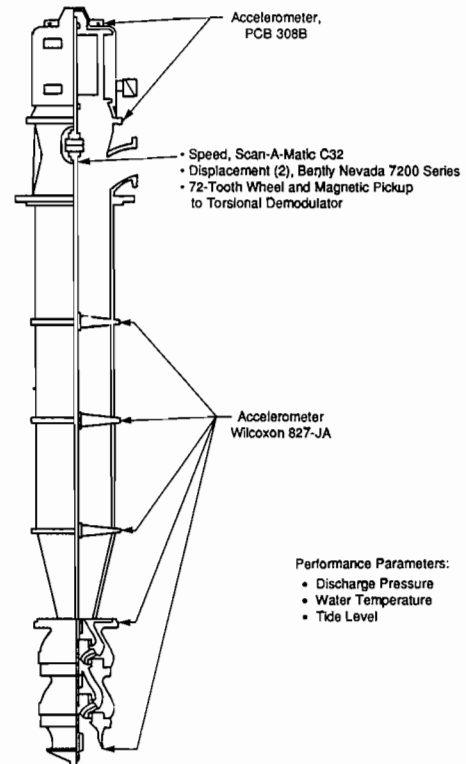

Figure 6. Sensor Placement.

#### MONITORING RESULTS

Baseline data for the service water pumps was tape recorded during initial start-up of the pumps after conversion to ASD operation. Following initial startup, both pumps have been monitored and trended online by an unattended automated remote monitoring system (ARMS). This remote system [6, 7] is used to collect, analyze, and trend changes in vibration and performance parameters. Processed data is stored on the computer's hard disk. Spectral information and reports of changes and trends in specific frequencies are transferred from the plant to offsite personnel via floppy diskettes for future analysis. The system also has the capability of transferring this data via modem and standard telephone lines.

Continuous vibration monitoring can result in mountains of data. An important feature of a monitoring system should be its ability to screen incoming data and store only meaningful changes in the spectra. The function of the remote monitoring system was used to monitor the service water pumps is shown in Figure 7. The system multiplexes to each selected sensor and, as appropriate, sets the antialiasing filter and sampling rate to

the proper frequencies, samples the data a user-specified number of times, and calculates an FFT. This sampling/FFT calculation is repeated a prespecified number of times. The FFTs are then averaged and stored. The averaged levels are then compared with previous levels. Those frequencies which have varied more than a prespecified amount are saved in trend and report files. The system then automatically multiplexes to the next sensor. The most recent spectra and all trend and report files are available to the user locally or can be off-loaded for further analysis. In addition to vibration sensors, the monitoring system also acquires data from various performance sensors to help assess the overall performance of the pumps.

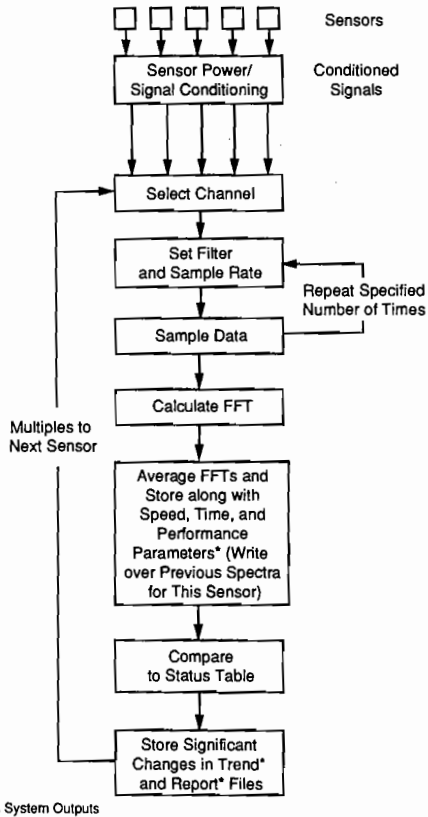

Figure 7. Operation of Remote Monitoring System.

Initial startup of the altered pumps disclosed a 1/2 running frequency component at maximum speed, principally at the motor upper bearings in both pumps. This subsynchronous frequency was not present at initial (cold) startup, but would soon appear and slowly vary in amplitude. While the levels on one pump (three mils, peak-to-peak displacement vs 0.5 mils at running frequency) were of some interest, the levels on the second pump (30 mils vs 2 mils at running) were of major concern. Several potential causes included instability in these plain sleeve bearings, oil whirl/whip, or a rub in the bearing area. In addition, plant personnel believed the high levels were perhaps caused by motor electrical problems. Subsequent rework of the second pump's motor upper bearing has reduced the 1/2 per rev frequency at maximum speed to less than one mil. The motor bearings from the first pump were also reworked, and the result has been lower 1/2 per rev vibration.

Typical once/rev vibration response of the pumps as a function of running speed is shown in Figure 8. The increase in mid-span vibration at high running speeds is attributed to once/rev excita-

tion of the pumps' third natural frequency. Analytically, this mode was predicted at 23 Hz for a newly modified pump (Figure 4). It was also postulated that the frequency for this mode should decrease as the pump wears. Test data shows that this frequency varies between 19 Hz (Figure 9) and 23 Hz. At 20 Hz and below, the natural frequency is within the pump's running speed range, and large forces can result. This change in resonance is attributed to the submerged depth of the pump, which varies as a function of the tide level in the East River. This alters the effective stiffness and damping present at the bottom end of the machine. The importance of measuring vibration within the submerged portion of the pump, is also shown in Figure 8. The pumps' exposed sensors do not detect the submerged vibration associated with this mode.

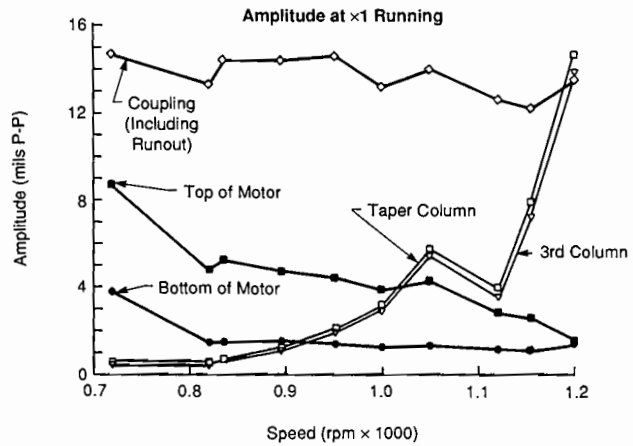

Figure 8. Lateral Vibration vs Speed.

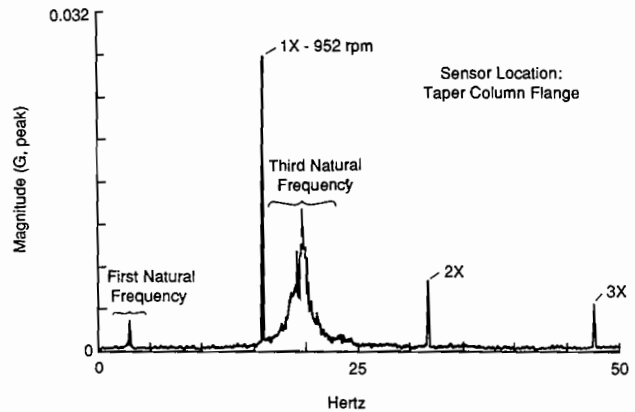

Figure 9. Location of Natural Frequencies.

The typical torsional response of the pumps as a function of pump speed is illustrated in Figure 10. This data is of special interest as it shows a peak response in the 1100 rpm range, and increasing response at maximum speed. These frequencies correlate well with the predicted torsional natural frequencies.

Before all sensors were installed, the shaft in one of the pumps failed at a notch between the two pump stages. Investigations concluded that the failure, which occurred after only 1000 hours of operation, was due to shaft bending stresses and an associated concentration of stress at the notch. We believe the lateral and torsional response encountered at fast pump speeds (required during summer operation) hastened the failure. The replace-

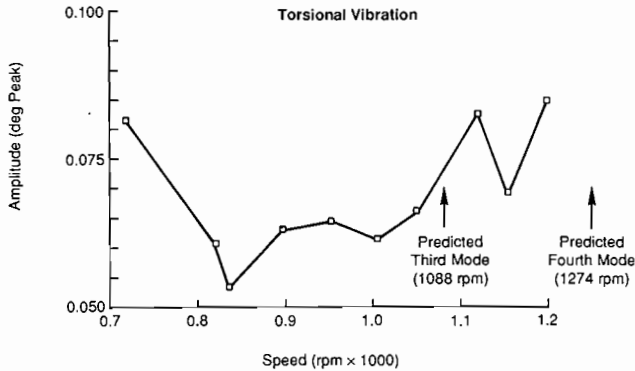

Figure 10. Torsional Vibration vs Speed.

ment shaft was manufactured without the notch. In cooler weather, the pumps typically run in the 700-900 rpm range. No subsequent problems have been encountered. Both pumps are now fully instrumented and the monitoring is continuing.

## RESULTS OF WORK ACCOMPLISHED

Analytical modelling and experimental testing of the modified pumps indicate that:

- The pump responds to a torsional natural frequency in the 1050-1120 rpm range.
- Depending on operation conditions (i.e., tidal height), a lateral natural frequency exists in the 1150-1200 rpm range.
- At speeds above 1150 rpm, a one-half running speed frequency is present in the pumps' vibration signature.

The following recommendations have been made:

- Avoid prolonged pump speeds above 1000 rpm.
- Continue to monitor the pumps for changes in operating profile.
- Use the computer models for guidance to evaluate design changes, including adjusting torsional and lateral resonances by adding another cutless bearing, changing the shaft diameter and/or modifying coupling properties.

These recommendations are presently under consideration. It is expected that the monitoring system will enhance the plant's ability to operate the pumps based on an accurate assessment of their mechanical condition.

## REFERENCES

1. O'Donnell, D., "New York Power Authority's Learning Experience for Installing Adjustable Speed Drives at the Charles Poletti Power Project," presented at EPRI Work-

shop "Adjustable Speed Drive Motors," Albany, New York (1988).

2. Electric Power Research Institute, FEATURE: Finite Element Analysis Tool for Utility Rotordynamic Evaluation, 1 Users' Manual, EPRI Research Project 1648-2, Computer Code Manual CS-3999-CCM (May 1985).
3. EPRI Final Report on Research Project RP2338-1, Vibration Monitoring of Vertical Pumps - Modelling Guidelines, NP-5704SP (1988).
4. COJOUR User's Guide: Dynamic Coefficients for Fluid Film Journal Bearings. EPRI Research Project 1648-1, Computer Code Manual, CS-4093-CCM (1985, 1988).
5. Black, H. F., "Effects of Hydraulic Forces in Annular Pressure Seals on the Vibrations of Centrifugal Pump Rotors," *Journal of Mechanical Engineering Science*, 11, (2), pp. 206-213 (1969).
6. Walter, T., "Automated Remote Monitoring Systems," presented at the International Conference on Condition Monitoring, Brighton, England (May 1986).
7. Frarey, J. L., and Eisler, E. A., "Remote Monitoring of Machinery," *Sound and Vibration Magazine* (October 1986).
8. EPRI Final Report on Research Project RP2338-1, "On-Line Vibration Monitoring of Submerged Vertical Shaft Pumps," NP-5704M (1988).
9. Walter, T., Marchione, M., and Shugars, H., "Diagnosing Vibration Problems in Vertically Mounted Pumps," ASME Design Technology Conference, Boston, Massachusetts (1987); *I10 Journal of Vibration, Stress and Reliability in Design* (April 1988).
10. Walter, T., Marchione, M., Kusaywa, W., Zelingher, S., and Cohen, R., "Vibration Analysis and Monitoring of Variable Speed Service Water Pumps," presented at EPRI Workshop "Adjustable Speed Drive Motors," Albany, New York (1988).

## ACKNOWLEDGEMENTS

The effort and support provided by Poletti personnel, especially Messrs. John Alois, John Mustaro and Mario Pactong, is greatly appreciated. NYPA staff personnel who supported the design and installation of the ASDs included Messrs. Richard Cohen, Dennis O'Donnell, and Chung Tsang. MTI personnel involved in modelling the pumps, installing the vibration monitoring system and assessing the resulting data included Messrs. Walt Kusaywa and Matt Marchione.