

PRINCIPLES AND APPLICATION OF A DIAGNOSTIC SYSTEM FOR MECHANICAL SEALS

by

Cord Schmidthals

Sales Engineer

Burgmann Dichtungswerke GmbH & Company KG

Wolfratshausen, Germany

and

Stephan F. Greitzke

Development

WILO GmbH

Dortmund, Germany



Cord Schmidthals is a Sales Engineer and Group Leader OEM Sales at Burgmann Dichtungswerke GmbH & Company KG, in Wolfratshausen, Germany. He has been with Burgmann since 1998 and is leader of the development project "Diagnostic System for Mechanical Seals." Previously, he was an International Sales Manager for Dataphysics Instruments at Stuttgart from 1997 to 1998.

Dr. Schmidthals studied technical Physics and received a degree in Physics (1993) from the University of Bayreuth, Germany. He received a Ph.D. degree (Physics, 1997) from the Max-Planck-Institute for Microstructure Structure Physics.



Stephan G. Greitzke has been working in development at WILO GmbH, in Dortmund, Germany, since 1988, in the field of electronically controlled drives of pumps for HVAC applications and building management systems (BMS).

Dr. Greitzke has a degree (Electrical Engineering, 1981) from the Technical University of Darmstadt. He worked as a scientific assistant at the Institute of Electrical Engineering, Technical

University of Braunschweig, where he received an Ing. degree (1988).

ABSTRACT

It is well known from long-term experience that life-cycle costs of a pump are determined by the consequential cost associated with pump failures. The failure of a pump, often originating from system-related nonpermissible operating conditions (early failure detection), will in many instances be caused by the failure of the mechanical seal. A system of reliably forecasting the remaining lifetime of a mechanical seal must thus be established in order to replace them during normal nonproductive periods before they finally fail (preventive maintenance). This diagnostic system, developed by a manufacturer of mechanical seals in collaboration with a pump manufacturer, comprises the necessary sensors and the pump integrated electronics. The required diagnostic software controlling the actual lifetime computation comprises user interfaces and, as the core of the diagnostic system, the so-called life-cycle algorithm.

FAILURE RATES OF MECHANICAL SEALS

The failures of glanded pumps are due, to a great extent, to mechanical wear (Figure 1). The wear on mechanical seals of glanded pumps begins earlier than, e.g., the wear on bearings of glandless pumps with hydrodynamical lubrication, by a factor of 10 (Greitzke, 2000). As shown in Figure 1, at the beginning of the life-cycle the failure rate initially strongly decreases with increasing time of operation. This can be attributed to the failure of mechanical seals and pump parts due to wrong installation and/or manufacturing defects. At longer operating times the failure rate remains constantly at a low level. In this period the failures are caused mainly by system-related nonpermissible operating conditions. At even longer operating times again an increase of the failure rate can be observed, which is related to the natural wear of mechanical parts in the pump and the mechanical seal. It must be observed that the failure rate λ is a statistical value depending on a variety of diversely possible operating conditions. This value can only reflect the probability of a failure but not its definite time. Two categories of causes of the failure of a mechanical seal can be distinguished:

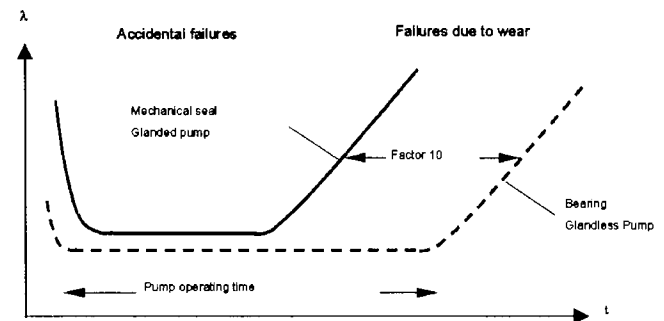

Figure 1. Typical Failure Rates $\lambda(t)$ of Glanded and Glandless Pumps.

- System-related causes, nonpermissible operating conditions
- Natural wear of the mechanical seal

From this introduction it becomes clear that a system for increasing safety and decreasing life-cycle costs must have the following properties:

- Detection of nonpermissible operating conditions that can be critical for the mechanical seal
- Detection of the natural wear of a mechanical seal and computation of its remaining lifetime

PRINCIPLES OF THE WEAR OF MECHANICAL SEALS

It is extremely difficult to make a generalized statement on the expected wear of mechanical seals. One of the reasons for that is the

multitude of influences on wear as well as their mutual influences on each other (Flitney, 1987). In conjunction with the diagnostic system there are mainly the influences of pressure and temperature that are of interest with regard to the wear and thus the lifetime of a mechanical seal. By lifetime the time period is meant during which the length of the seal ring is reduced to a minimum due to natural wear and at which further wear would lead to a definite leakage.

The influence on wear of pressure and then of higher temperatures will be discussed.

After the theory of Archard (1995) and Holm (1958), the so-called adhesive wear is described according to Mayer (1982):

$$A = \frac{Z \cdot p_g \cdot v_g}{H} \quad (1)$$

Here, Z represents the wear, p_g the slide pressure, v_g the slide velocity, and H the hardness of the harder slide materials used. This simplified relation must be used with caution since the influences of the fluid on the wear, the frictional conditions, and the temperature have not been taken into account. It must especially be observed that a higher slide pressure will generally lead to a higher temperature in the seal gap, thus adding to the influence of the temperature of the product. Contradictory to Equation (1) a superlinear increase of the wear due to the slide pressure has been noted in many investigations (Johnson, 1956).

Early investigations of the life expectancy of balanced mechanical seals (Williams, 1965) yielded a life expectancy of about three years at a working pressure of 5 bars (73 psi). With increasing pressure, the life expectancy is considerably reduced. However, the investigation showed that the life expectancy decreased less than linear with increasing pressure. Thus Equation (1) will at least provide qualitatively correct results. Long-duration tests on mechanical seals of water circulating pumps (Mayer, 1968) have proved that lifetimes of approximately 100,000 operating hours can be expected under certain constant operating conditions. Such extremely long service life will only rarely be reached in practice, because any increase of glide pressure, friction coefficient, glide velocity, or temperature will increase the wear and thus shorten the lifetime. The temperature of the gliding faces has, apart from the influence of pressure, a decisive influence on the wear of the seal faces. A temperature increase can result in a reduction of stability, hardness, or a disintegration of the impregnation of the carbon materials (Nau, 1990).

The influence of temperature on the wear of carbon materials for different steel qualities (Johnson, 1956) is depicted in Figure 2. From the figure it becomes clear that with increasing temperature, the wear (denoted A) increases drastically. Today, the values of the wear usually found for mechanical seals are smaller by a factor of 100 to 1000 due to improvements of the carbon materials. However, the tendency of increasing wear with increasing liquid temperature can also be found in today's seals. Empirical tests on the lifetime of mechanical seals at different temperatures (Flitney, 1976) have shown that life expectancies of five years at operating temperatures of less than 50°C (122°F) can also be achieved in practice.

It becomes apparent from the previous discussion that both pressure and temperature have a large influence on the wear and thus the life expectancy of a mechanical seal. As mentioned at the beginning, other influences also play a role in the determination of wear. Due to the complex mutual interactions of these influences and the pressure as well as the temperature, it is very difficult to make a reliable forecast of the life expectancy. It is thus necessary to determine the wear on a seal in experiments. For the use of a seal in practice, the seal type, the used material combinations, and the fluid are mostly fixed. Provided that the sliding velocity varies only slightly it will, in such experiments, be sufficient to vary pressure and temperature and measure the resulting wear. The disadvantage of this procedure is that the results cannot be easily applied to other types of seals, materials, and fluids.

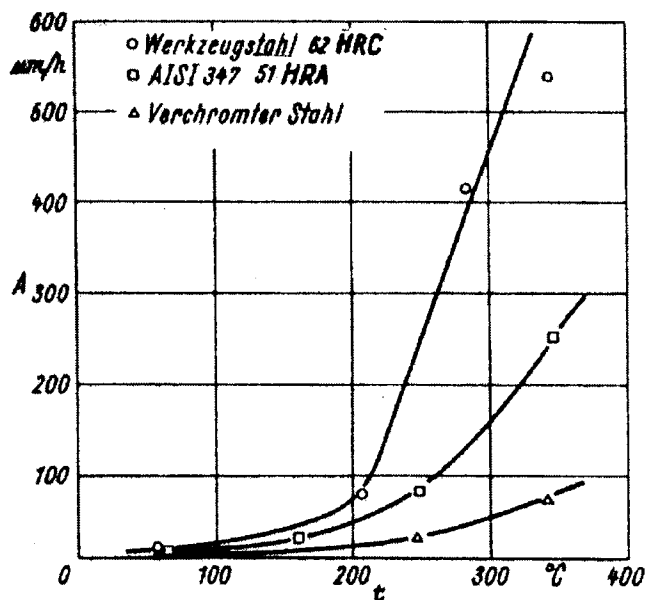

Figure 2. Lifetime of a Mechanical Seal Depending on Pressure and Fluid Temperature (Johnson, 1956).

DIAGNOSTIC SYSTEM FOR MECHANICAL SEALS

Experimental Details

All experimental data were obtained using a rubber bellows seal with a shaft diameter of 32 mm (1.26 inch) mounted into a commercially available pump for heating applications. A schematic drawing of the seal used is shown in Figure 3. The seal face was made of antimony impregnated carbon and the stationary seat was made of silicon carbide (SiC). Due to the flexible rubber bellows, the balance ratio increases with increasing pressure as shown in Figure 4.

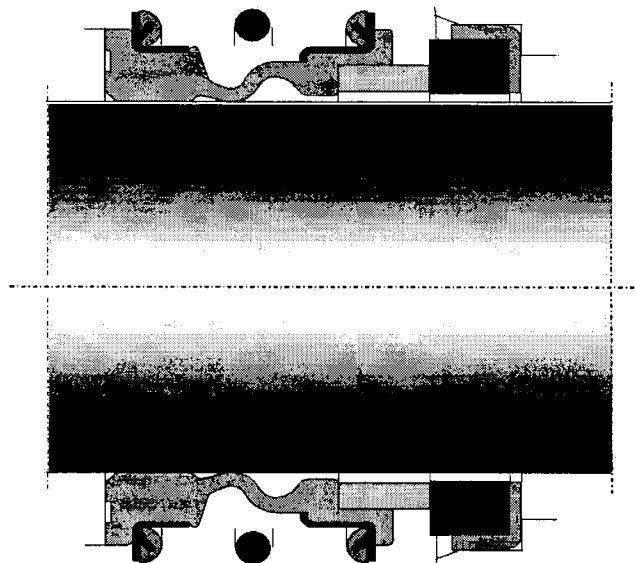

Figure 3. Sketch of the Rubber Bellows Seal Used to Determine the Wear Rates.

Each seal was tested at each operating condition for 100 hours. In order to determine wear rates at varying temperatures and pressures, the height of the carbon was measured before and after the test run with a height measuring instrument with an accuracy of 0.5 μm. On the circumference of the seal face, four points about

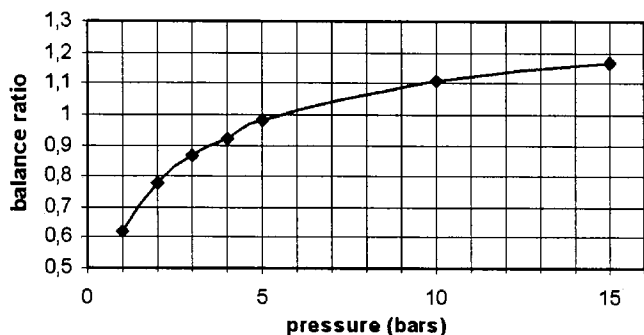

Figure 4. Experimentally Determined Balance Ratio of the Rubber Bellows Seal Used for the Diagnostic System.

90 degrees apart were selected, and the height was determined by calculating the average value. After each test run the seal faces were repolished. The mean roughness was checked to be below 0.1 μm and the deviation from an ideal flat surface was not bigger than 1 μm peak-to-peak. All experiments were carried out using deionized water with an electrical conductivity of 1 μS/cm.

Lifetime Algorithm

The basis to determine the remaining life expectancy of a mechanical seal is the so-called lifetime algorithm, which contains the detailed knowledge of relevant operating conditions as well as their influence on the wear of the seal. This influence has been experimentally determined at temperatures of 70°C, 110°C, and 140°C (158°F, 230°F, and 284°F) and different pressures. The lifetimes to be expected at such operating conditions are depicted in Figure 5. Note, that the lifetime shown in Figure 5 is the time after which the carbon face is worn down to a point that any further wear would lead to a significant leakage of the seal. Seal failure due to any other failure mechanism is not taken into account in the data shown in Figure 5. Further experiments to include other failure mechanisms are currently in progress.

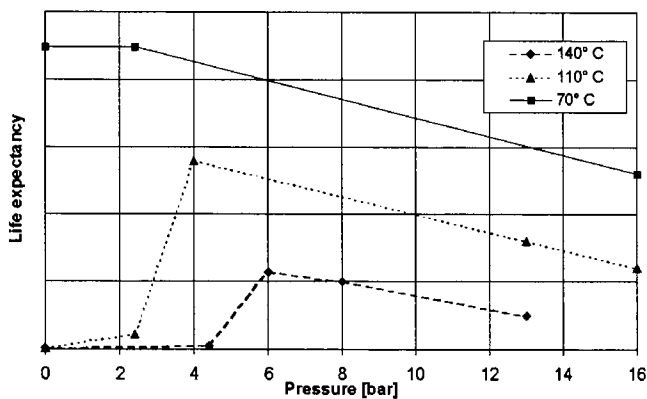

Figure 5. Experimentally Determined Lifetime of a Mechanical Seal Depending on Pressure and Fluid Temperature.

As evident from the diagram, the life expectancy decreases with rising pressure and temperature. This corresponds to the theoretical expectation depicted in paragraph two. The steep decrease in lifetime at 110°C and 140°C (230°F and 284°F) at small pressures is due to the operation at a point below the vapor curve (high temperature and low pressure), leading to a very high rate of wear and thus a low life expectancy of the seal. From knowledge of the expected lifetime at the three temperatures and different pressures, the performance at other operating conditions can be deduced by linear interpolation. The functional relation of the lifetime as a function of temperature and pressure is integrated in the software of the diagnostic system and is the core of the life expectancy calculation.

The fluid temperature, the pressure, as well as the temperature of the stationary ring of the mechanical seal are continually measured during the operation of the diagnostic system. The temperature at the stationary ring is being utilized to detect dry-running at the seal by taking a temperature difference between the pumped fluid and the stationary ring of more than 50 K as an indicator for dry-running of the mechanical seal.

A possible arrangement of the respective sensors is shown in Figure 6. The sensors for pressure and temperature of the fluid, integrated in a single housing, are mounted in the pump discharge flange. The temperature sensor is arranged in a way that the temperature is measured directly in the fluid stream. The temperature at the stationary ring is measured at a distance of approximately 1 mm (.3937 inch) from the sliding face of the mechanical seal, thus ensuring a correct reading of the temperature of the sliding surface.

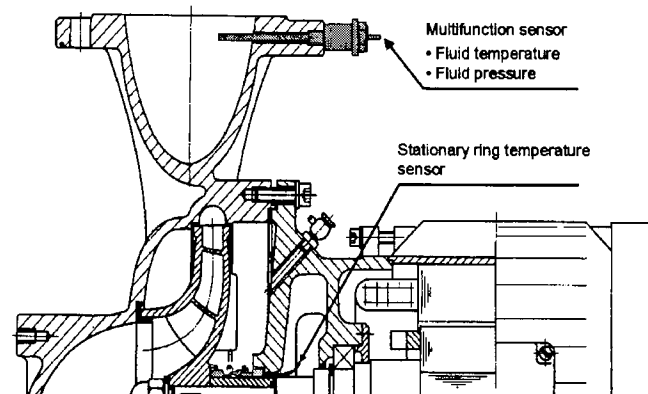

Figure 6. Cross Sectional View of a Glanded Pump with Integrated Sensors for the Seal Diagnostic System.

A wear factor is attributed to each operating condition with the aid of the lifetime algorithm. The measured running time is weighted by the wear factor for each operating condition and then subtracted from the initial life expectancy. With this procedure it is possible to determine the remaining life expectancy depending on the operating conditions run through in the past. Critical operating conditions, such as dry-running, operating close to the boiling point, as well as operation at excessively high fluid temperatures are treated in the same manner as normal operation. Each critical operation condition is attributed an accordingly high wear factor.

Warning of Intolerable Operation Conditions

While all the time periods in each operating condition are being summed to determine the remaining life expectancy, any possible fault conditions (early failure detection or EFD) at the mechanical seal must be immediately noticed by the system management system (fault signals). The plant operator is thus enabled to initiate remedial measures and to rectify the actual fault causes for the seal failure. Maintenance and fault consequential costs are thus reduced and the safety of the plant is increased.

Example—Operations Near the Boiling Point

In the operation of plants, there are various reasons causing a pressure decrease or a strong increase of product temperature. For example, defective expansion vessels in heating installations or insufficient inlet pressure can cause such a critical operating condition. This can lead to a partial evaporation of the product, resulting in insufficient hydrodynamical lubrication of the seal faces and consequently in premature aging of the faces (“failure due to wear”). The boiling region as defined in the diagnostic system is shown in Figure 7. The distance between the two curves accounts for the fact that the fluid pressure is measured at the flange and not directly at the mechanical seal (refer to Figure 6).

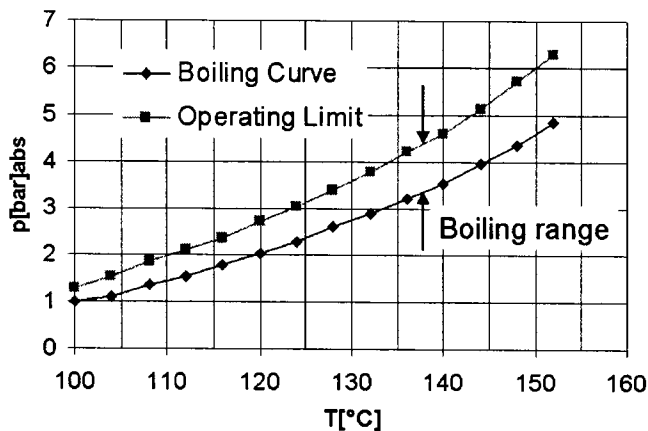

Figure 7. Implemented Alarm Limits of the Diagnostic System for Operations Near the Boiling Point.

Example—Dry-Running of the Pump

Mechanical seals must not be operated in dry-running conditions. The temperature sensor integrated in the stationary seal ring serves to detect such an intolerable condition. The characteristic temperature rise, together with the fluid temperature as a reference value, is used to indicate the dry-running condition. To document this, Figure 8 shows the relation of seal temperature versus time for several instances of deliberately induced dry-running of the mechanical seal.

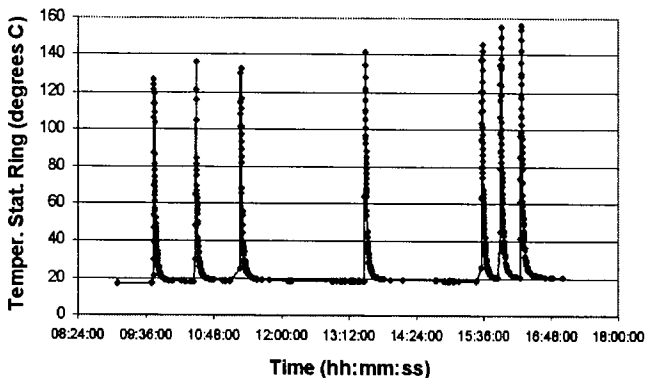

Figure 8. Temperature at the Stationary Seal Ring for Determination of Dry-Running of the Mechanical Seal.

Figure 9 shows a photograph of the stationary ring as used in the diagnostic system. For measurement of the seal temperature, the temperature sensor is glued directly into the seal ring made from SiC. Thus, a reliable and accurate measurement of the seal face temperature can be carried through.

Scheme of Data Processing and Data Transmission

Figure 10 shows a condensed version of how the values received by the sensor are registered, processed, and displayed by the diagnostic system. The relays can be used to switch off the pump or to activate any remote signal according to the current status of the diagnostic system.

CONCLUSION

Figure 11 shows a view of the diagnostic system for mechanical seals. All signals are led into the control and operating unit through PG cable glands. The control unit is designed in a way that two-pole air-ventilated motors of various power ratings can be combined with the unit. With the aid of the display, the parameters necessary for the first run can be set and all memorized operating conditions can be read out menu-guided for a possible fault

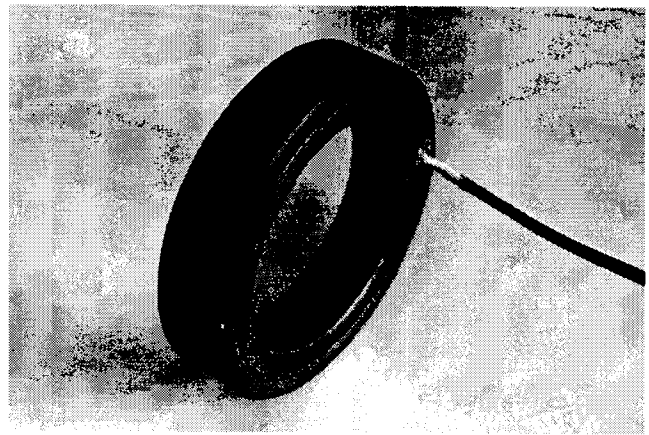

Figure 9. View of the Stationary Seal Ring of the Diagnostic-Equipped Mechanical Seal with Integrated Temperature Sensor.

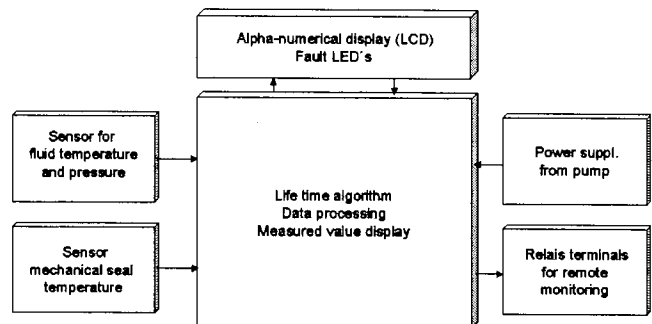

Figure 10. Scheme of the Diagnostic System with Sensor Inputs, LCD, LEDs, and Relay Outputs.

analysis. Red and yellow light emitting diodes (LEDs) indicate current fault conditions or an ending lifetime of the mechanical seal. The possibility of preventive maintenance (PM) as well as the continuous monitoring (EFD) of the mechanical seal will extend periods between maintenance and may partly avoid maintenance service calls, resulting in reduced life-cycle costs (LCC) and increased safety of the plant.

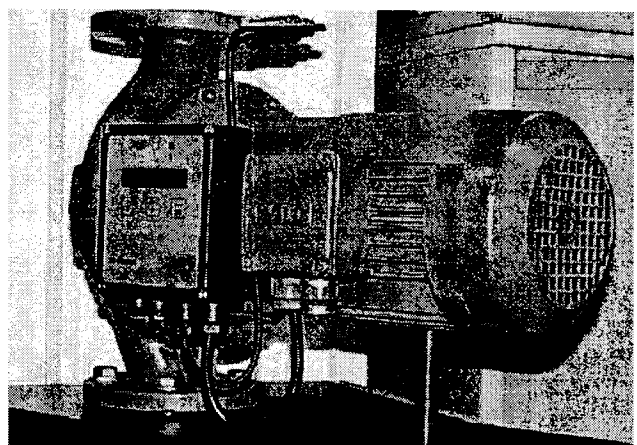

Figure 11. Glanded Pump with Integrated Diagnostic System for Mechanical Seals.

Since March 2000, five diagnostic systems have been installed in heating systems of big buildings, e.g., hospitals. The seal being used is a rubber bellows seal, as shown in Figure 3, for a shaft diameter of 32 mm (1.26 inch). The maximum temperature is 140°C (284°F) and the maximum pressure is 16 bars (232 psi). The

liquid sealed in the field test is water with anticorrosion additives. Deliberately induced and accidental fault conditions, like operation in the boiling range, were reliably detected. The operation of one specific heating system was optimized as a consequence of the data collected by the diagnostic system. Thus from the field test, application of the diagnostic system has already benefitted the user of the heating system. Due to the long lifetime of the mechanical seal under normal operation of several thousand hours, an end of the lifetime has not been reached yet. Therefore a final statement about the correct calculation of the remaining lifetime cannot be made yet. Additional field tests in chemical plants and refineries are in preparation.

REFERENCES

- Archard, J. F., 1995, "Contact and Rubbing of Flat Surfaces," *Journal of Applied Physics*, 24.
- Flitney, R. K. and Nau, B. S., 1976, "Seal Survey: Part 1—Rotary Mechanical Face Seals," BHRA Report CR1386.
- Flitney, R. K., 1987, "A Study of Factors Affecting Mechanical Seal Performance," *Proceedings of Institution of Mechanical Engineers*, 201, (17).
- Greitzke, S. F. and Strelow, G., 2000, "Reliability Considerations Applied to Serial Pumps-MTBF Analysis," *Pump Users International Forum*, Karlsruhe, Germany.
- Holm, R., 1958, *Electric Contact Handbook*, Third Edition, Berlin, Germany: Springer Verlag.
- Johnson, R. L., Swikert, M. A., and Bailey, J. M., 1956, "Wear of Typical Carbon-Base Sliding Seal Materials at Temperatures to 700°F," NACA Report 3595.
- Nau, B. S., 1990, "Research in Mechanical Seals," *Proceedings of Institution of Mechanical Engineers*, 204, (349).
- Mayer, E., 1968, "Gleitringdichtungen für Verbrennungsmotoren, elektrische Maschinen und Sondergetriebe," *Konstruktion* 20, 2.
- Mayer, E., 1982, *Axiale Gleitringdichtungen*, Seventh Edition, Düsseldorf, Germany: Verlag des VDI.
- Williams, J. G., 1965, "Shaft-Seal Systems for Large Power-Reactor Pumps," *Nucleonics*, 23, (2).

