

MECHANICAL SEAL CHAMBER DESIGN FOR IMPROVED PERFORMANCE

by

Neal D. Barnes

Project Manager, Rotating Equipment

Robert K. Flitney

Manager, Industrial Applications

and

B. S. Nau

Manager, Fluid Sealing Technology

BHR Group Limited

Cranfield, Bedford, United Kingdom



Neal D. Barnes joined BHRA in 1984 after receiving his BSc degree in Mechanical Engineering at Leeds University. He has worked extensively on research on mechanical seal and seal housing design and reliability. He recently completed a Ph.D. thesis, "Fluid Flow and Heat Transfer around Mechanical Seals."

Dr. Barnes is currently managing a number of rotating equipment projects, including mechanical seals, multiphase pumping

and pump testing. He has written several papers on mechanical seals and contributed to textbooks. He is a member of the BSI committee on standards for seal housing design.



Robert K. Flitney joined BHRA (1969) after completing an Engineering Apprenticeship with BP Tankers Limited, followed by service at sea with steam turbine vessels. He has worked on fluid sealing projects involving mechanical and polymeric seals. His projects include industrial and military development programs, and multisponsor consortium research and development projects.

He shared the 1986 Mond prize of the Institution of Mechanical Engineers for a technical paper on mechanical seal performance.

Mr. Flitney chairs the ISO committee on reciprocating seals for fluid power applications, and is also a member of several other committees on mechanical and reciprocating seals. He is an ASME member.



B. S. Nau received a physics degree from Imperial College (1959). He conducted mechanical seal tribology research in the Mechanical Engineering Department before joining BHRA as a Staff Research Engineer. He completed his Ph.D. in 1967. He was assigned in 1969 to an U.S. Navy project at the University of Tennessee.

Dr. Nau's interests include fluid sealing technology, tribology, polymeric and ceramic seal materials. He has managed the

fluid sealing activity at BHRA (now BHR Group Limited) for 25 years. He is involved in I.Mech.E committees, and British and European standards committees on fluid sealing.

He is a member of the PVRC committees on bolted flanged connection design. He was awarded the Tribology Silver Medal (1985) and delivered the 1990 BP/I.Mech.E Tribology Lecture. He is an ASME member.

ABSTRACT

The influence of pump chamber design on the environment, and mechanical seal reliability has been the subject of a major collaborative United Kingdom study. The key mechanisms involved in controlling the flow regimes around the seal are highlighted. Current practice is reviewed and shows that many seals are operated in chambers not well suited to their functional requirements: heat transfer, vapor and solids control. The experimental techniques are described, including flow visualization and measurements of heat transfer from the seal to its surroundings by hot film anemometry. The work highlights that a highly constrained cylindrical seal chamber, commonly used in practice, provides a poor seal environment. A seal chamber with controlled flow structure, and in particular a flared cavity, gives significantly better performance.

INTRODUCTION

The environment around a mechanical seal strongly influences seal reliability, performance and life. The fluid around the seal is crucial as interface lubricant and transport medium for heat, gas, vapor and solids. Flow regimes within the chamber control the processes, and are, therefore, crucial in the design of reliable seal installations. Until now, a poor understanding of the processes has mitigated against the optimization of the chamber geometry, flushing arrangements, influence of neck bushing, and injection angle.

The chamber issue is complicated by the fact that chamber design is rarely under the control of the seal manufacturer. Often it is specified by functionally unrelated, dimensional standards such as API 610, ANSI B.73, ISO 3069, and DIN 24960. In most cases the dimensions were based originally on requirements for soft packing and, consequently, result in axially deep, radially constrained cavities, namely "stuffing boxes" (Figure 1). These geometries arise where standards require alternative use of mechanical seals or soft packing, despite the fact that the majority of centrifugal process pumps are fitted with mechanical seals and are

unlikely to be refitted with packing. Stuffing box configurations limit the seal design to a slender low rigidity configuration; this too mitigates against good performance. The 7th edition of API 610, however, does now allow more radial space around the shaft for high duty mechanical seals.

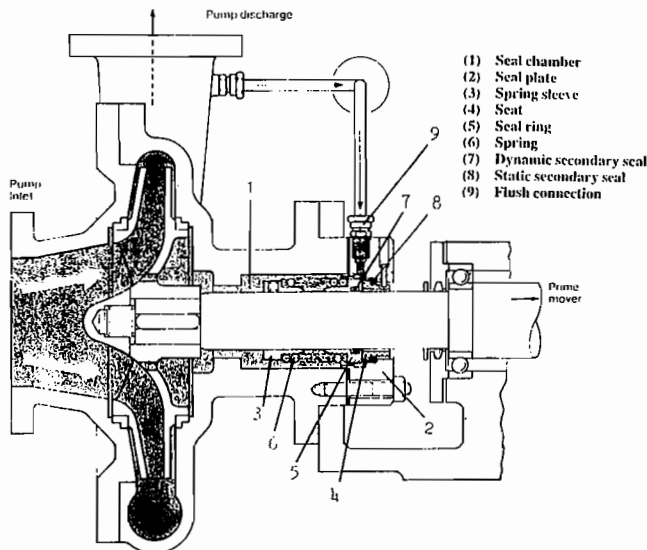

Figure 1. Traditional Mechanical Seal Chamber, Based on Stuffing Box.

None of the standards does more than specify minimum values of radial clearance around the seal. The standards do not consider optimization of flow regimes for the efficient removal of heat, gas, vapor, or solids. The consequential need for independent seal flushing systems, expensive and fallible, reflects the inadequacy of such seal installations.

THE LITERATURE

Calls for the adoption of correctly designed seal chambers, as opposed to use of stuffing boxes, have been made in the published literature for a number of years. Sangerhausen [1] reported problems with failures of seals operating on light hydrocarbons. He found that a major cause was the loss of face lubrication and cooling due to accumulations of vapor around the seal. Ingram [2] also reports poor seal environment as a principal cause of seal failure and suggests that expecting the mechanical seal to operate in a cavity designed for soft packing is a contributory factor. Bloch [3] blames the housing size limitations dictated by current standards and practice for impeding the implementation of advanced mechanical seals. He recommends the adoption of housings with a tapered bore and open to the rear of the impeller, thereby allowing the seal to be product flushed (i.e., dead ended). Bloch reports that a number of pump manufacturers have advocated and now offer ranges of pumps incorporating a flared or bell-shaped housing. One such design was put forward by Heald [4] with a patented design incorporating flow guides (Figure 2). The main application of bell housings to date has been on slurry pumps, particularly for flue gas desulphurization duties, where the seal must be run without an external clean flush. A number of authors have reported the merits of this approach: Bangert [5], Dosch [6], Heumann [7], Schopplein [8], and Battilana (undated). A number of seal and pump manufacturers have reported favorably on the results of inhouse studies, including: Standish [10], Adams and Van Hie [11], Antkowiak [12], and Davison [13]. Davison gives some experimental data based on lab measurements of seal cham-

ber temperature. These show that a highly constrained chamber runs some 40° to 50°F hotter than his more open parallel designs (Figure 3).

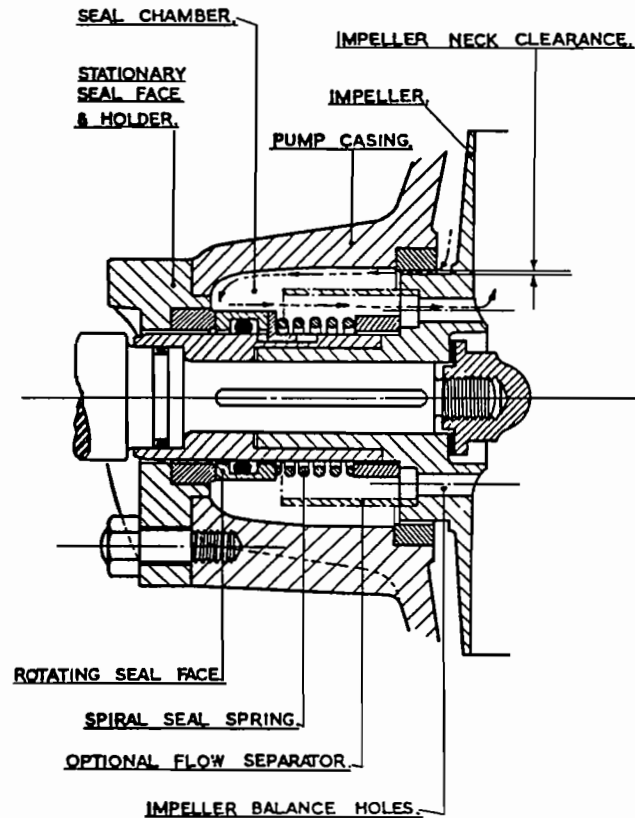
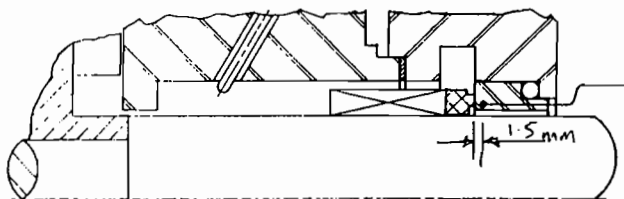

Figure 2. Patented Seal Chamber Design [4].

The preceding supports the concerns of those who have been unhappy with "standard" seal chambers. The general consensus is to recommend a move towards wider chambers, although the geometries reported are parallel or approximately parallel chambers, not the wide flared or bell housings advocated for slurry pumps. In recent years, pressure has been growing to adopt this improved technology. Although many of the above claim enhanced seal life and reliability none, except Schopplein, detail their experimental techniques and data.

Little analytical or experimental work of substance has been reported in the literature pertaining to flow regimes and heat transfer within seal chambers. As long ago as 1965, Lymer and Greenshields [14] suggested that the forced convection generated by the rotating shaft and seal were of importance in the cooling of the seal. In particular, they postulated that the toroidal or Taylor vortices (first reported by Taylor [14]) intrinsic to rotating annular flow would most probably be formed in the seal chamber despite the complex external geometry of many mechanical seals. Work by Gazley [16] on the flow patterns and cooling of motor rotors lent substance to this assumption. Gazley found that slots on the rotor had a negligible effect on the vortex flow or heat transfer coefficients.

The lack of detailed information on optimum seal housing design has been a major obstacle to the upgrading of dimensional standards for seal cavities. Nau [17] in an assessment of the current practice, recommended that detailed experimental investigations of the flow phenomena and their influence on transport processes



Standard Stuffing Box, Pump A.

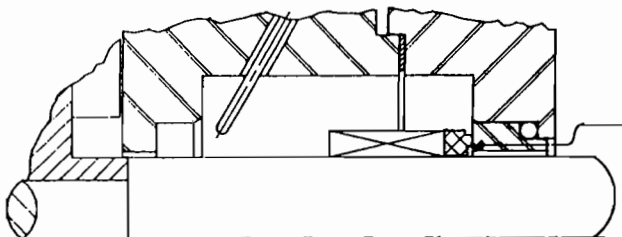

Enlarged Cylindrical I Seal Chamber, Pump A.

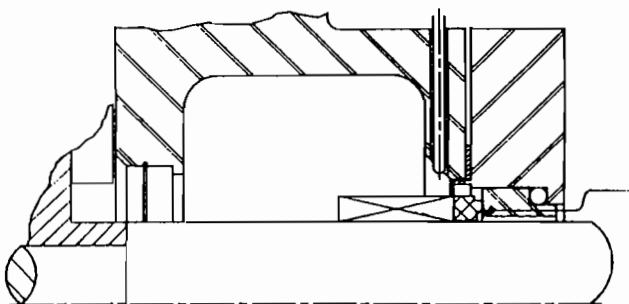

Enlarged Cylindrical II Seal Chamber, Pump A.

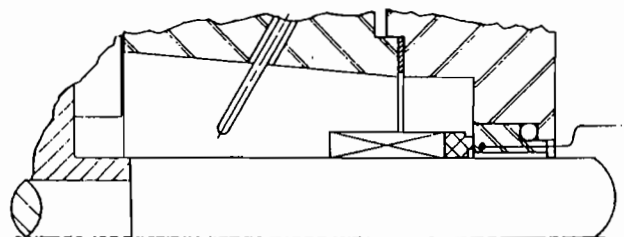

Enlarged Tapered Seal Chamber, Pump A.

Figure 3. Seal Chamber Designs Tested by Davison [13].

would be a prerequisite for the drafting of functional standards for optimizing seal chambers.

ROTATING ANNULAR FLOWS

In order to predict the movements of heat, vapor bubbles, and solid particles within the seal chamber, it is necessary to know something of the likely types of flow regimes to be generated. The rotation of a complex body, such as the rotating component of a mechanical seal, will probably develop very complex flows associated with the steps, springs, cutouts, etc. However, as a first approximation, the seal may be considered as a smooth circular cylinder rotating inside a cylindrical housing. A considerable amount of work on this flow system has been reported and the main conclusions are of value.

Several distinct flow regimes occur in an annular clearance where the inner member rotates. The flow system is inherently unstable and attempts, given the correct conditions, to resolve

itself into a series of counter-rotating toroidal vortices (Figure 4). The existence, or otherwise, of the vortex structure depends on the ratio of inertial to viscous forces, expressed as the dimensionless Taylor number [Ta], where:

$$Ta = \omega^2 r b^3 / \nu^2 \tag{1a}$$

or

$$Ta = Re^2 \cdot (b/r)^3 \tag{1b}$$

Consequently, at low Taylor numbers, viscous forces dominate and suppress the inertial forces and the flow is laminar. At a Taylor number of 1708, the inertial forces become comparable with the viscous forces and Taylor vortices are formed. The presence of vortices has several effects: heat transfer coefficient is improved (presumably because the velocity gradient at the heat transfer boundary is increased by the vorticity). They overcome the centripetal forces which trap gas or vapor against the shaft and, instead, draw the gas into the vortex cores; and, lastly, they entrain suspended solids into the vortex peripheries. At higher Taylor numbers (>10⁵) where many mechanical seals operate, the vortices tend to be broken down by turbulent eddies. Under certain conditions, however, a turbulent vortex structure re-forms (Figure 5).

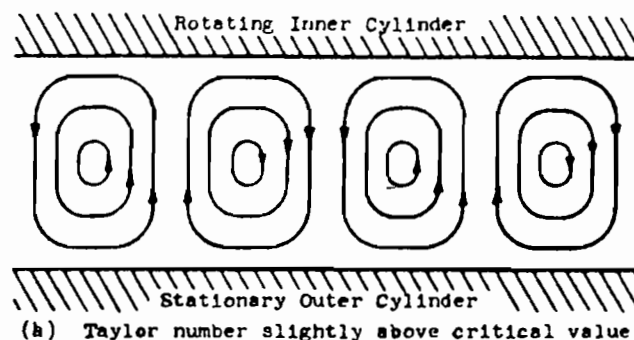

Figure 4. Taylor Vortices Generated by Rotation of the Inner Cylindrical Wall of a Long Annular Chamber.

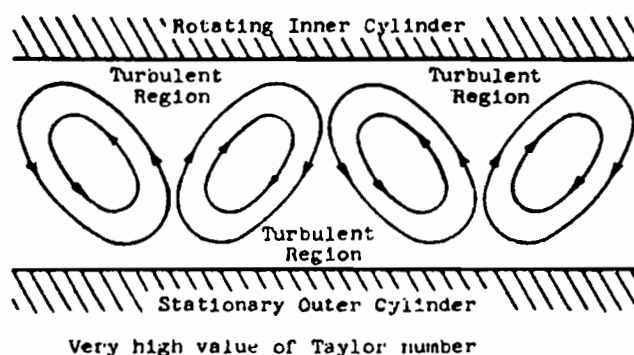

Figure 5. Reformation of Structured Vortex Flow at High Reynolds Number.

Given the fluid viscosity, seal geometry, and speed, the only variable available for influencing the Taylor number (i.e., the flow regime) is the radial clearance. In other words, the design of the seal chamber could directly, and potentially crucially, affect the regime around the seal.

Although the work on rotating annular flows is a key to the understanding of seal chamber flows, it should be kept in mind that

the real situation is somewhat more complicated. A typical seal chamber will have a rotating inner cylinder of irregular exterior and of finite length and a small length-to-gap ratio. Many real fluids are not single phase, but may have gas, vapor, or solids entrained. Furthermore, in some cases, the fluid may be highly non-Newtonian. Other factors may also be important, for example: seal design, piping plan, injection angle, injection flowrate, and the presence of neck bushing.

The variety of complicating factors emphasizes the need for additional experimental work to study these areas and highlights the preference for using flow visualization techniques to determine the flow patterns. On the basis of what is reported, and using some reasonable assumptions, it is possible to construct a conceptual picture of what a typical seal chamber may look like (Figure 6). The influence on the transport processes is considered in the following text.

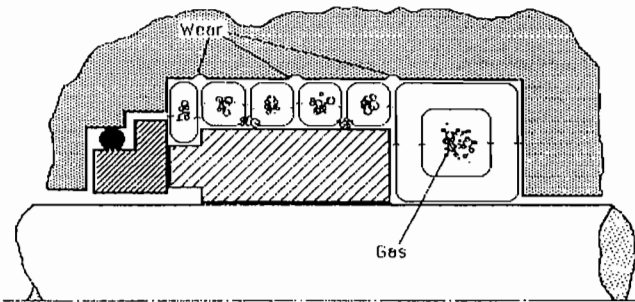

Figure 6. Generalized Seal Chamber Flow Pattern Based on Observations of Flow in Actual Seal Chambers.

Heat Removal

Removing heat from the sealing interface film is often the most important function of the fluid in the seal chamber. A mechanical seal can dissipate considerable power, even some kilowatts, in the chamber. The convective heat transfer coefficient therefore needs to be high to ensure rapid heat removal to a sink such as the pump body or coolant flush. If the seal chamber temperature rises due to inadequate heat removal, the likelihood of interface film vaporization increases. This leads to seal instability, and may distress the seal faces and cause failure. Improving convective heat transfer by controlling the flow regime increases the available temperature margin, ΔT , of the seal.

Vapor and Gas Control

There are usually two main sources of vapor in the seal chamber. First, it can originate from the seal interface film if vaporization is occurring, and second, there may be gas or vapor in the process fluid itself. Due to the mechanics of the system, much of the vapor will be centrifuged inward to the pump shaft and into recesses along the seal. In particular, the design of most seals creates a circumferential recess at the seal face, due to the narrower nose of one face. Vapor or gas are readily trapped as orbiting bubbles in this recess, with possible adverse effects on the sealing interface. Ultimately, the bubbles join up to form a continuous toroid which effectively isolates the faces from the cooling liquid [18] and causes the seal faces to run hotter, this condition can be termed "vapor locking." A vapor locked seal will stand little chance of survival.

Solids Control

Most processes carry some suspended solids which will find the way to the seal chamber. Commonly these particles are rust, silica or wear debris. In the extreme, where the product is a slurry, solids

may form a very high percentage of the slurry. Solids are most harmful when they penetrate the sealing interface; once embedded in a soft material, they may break up the film and cause extra heating and wear. Coarse particles can also cause problems of erosion within the seal chamber and cases of severe concentrated erosion in practice are known to the authors. It is likely that the process of local erosion is accelerated by a vortex like feature entraining solids and effectively creating a grinding wheel. Some pumps are fitted with so-called "vortex-breakers," which are reported to help ameliorate this damaging phenomenon.

TEST PROGRAM

A detailed study of the seal chamber environment was one of the tasks addressed by the research group (others including seal performance evaluation, seal material testing and face material quality assurance, and the effects of pump misalignment and vibration).

Scope

The housing optimization study is ongoing and only Phase 1 work is reported here. Phase 1 was mainly concerned with tests on traditional and alternative seal chamber geometries, including: narrow (based on current standards) and wide parallel housings, tapered housings with shallow (12 degrees) and steep (45 degrees) flares. Other variables investigated were: effects of seal design, five generic seal types:

- Exposed single-spring
- Shrouded single-spring
- Multiple spring
- Rotating metal bellows
- Stationary metal bellows

Another factor studied was the API piping plan, injection angle (radial or tangential), the presence of a neck-bush between seal chamber and pump impeller, rotational direction.

Ideally a "good" housing should be insensitive to these variables.

Equipment

A test stand was built to simulate a process pump set (Figures 7 and 8). The modular construction of the test chamber changes to a large range of design or operational variables. Transparent components allowed detailed flow visualization observations to be made. Flow patterns were filmed using a video camera fitted with a macro lens, still photography and stroboscopic techniques were also employed. Circulation and housing parameters logged included temperatures, pressures and flowrates. The seal shaft was direct driven by a 7kW, 0-6000 rpm DC motor, with tachometer and power meter. Two seal rotors were fitted with flush mounted hot film anemometer probes (Figure 9). These function in the same way as hot wire anemometers and were used to determine convective heat transfer coefficients between seal and surrounding fluid.

Fluids included water and water/glycerol solutions, viscosity from 1.0 to 150 cS. Air bubbles were injected as a flow tracer. Solid particles of different densities and sizes were added to the fluid in some tests.

FLOW OBSERVATIONS

Over 100 hours of video film of housing flow patterns were recorded and analyzed. Some salient features of the flow visualization are summarized below.

Narrow Parallel Housings

When run dead ended (Figure 10), air accumulated in the vicinity of the seal, usually trapped in well defined discrete bands

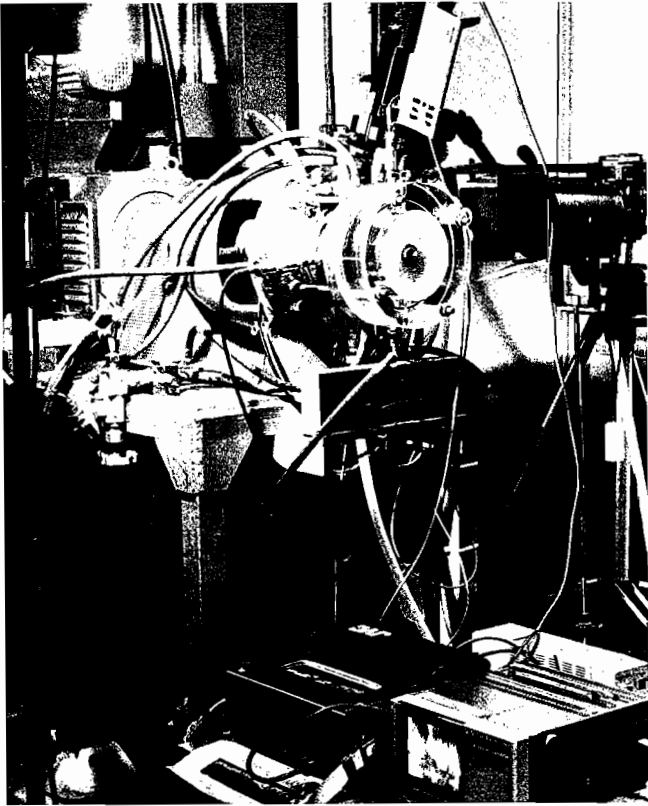

Figure 7. General View of Test Equipment, Transparent Housing Top Right.

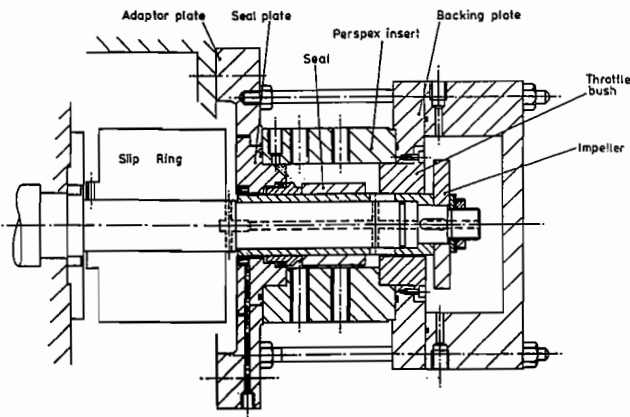

Figure 8. General Arrangement of Test Chamber.

along the length of the seal rotor. No such bands were visible around the single-spring seal (Figure 11). This seal promoted vapor removal when run counter-clockwise, by pumping away from the seal faces. Running with the higher viscosity fluids resulted in a large gas cavity forming over the seal face. This was only removed by introducing an independent flush to the seal faces.

The best operating mode for the narrow parallel housing was achieved by adding a flush to the seal faces (Figure 12). Generally, this was sufficient to remove the air from the seal face recess but not from within the seal rotor, where air was seen to accumulate in cutouts and around the springs (Figure 13). Above 3000 rpm, the

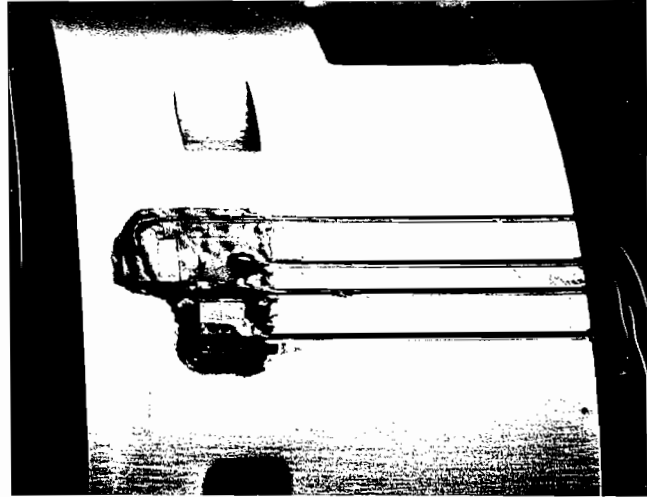

Figure 9. Heat Transfer Probes Installed on a Seal Rotor.

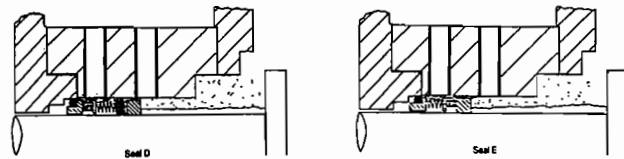
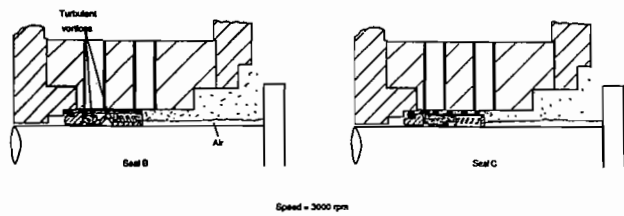

Figure 10. Narrow Parallel Housing. Dead ended, no bush, four seal types. Gas/vapor localized between seal and chamber wall.

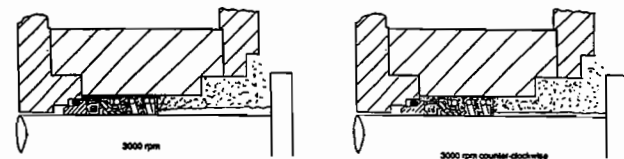
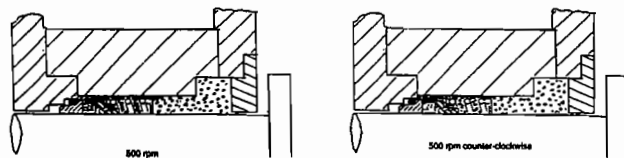

Figure 11. Narrow Parallel Housing. Dead ended. Exposed spring with rotation counter-clockwise evacuates gas from seal face area.

effectiveness of the flush diminished. Tangential injection did not give any marked benefit over radial injection. Indeed, injection in the direction of rotation reduced the air purging efficiency. Multipoint injection was beneficial in many cases and never degraded performance. The housing was a poor performer when solids were present, as dense accumulations built up around the seal faces (Figure 14).

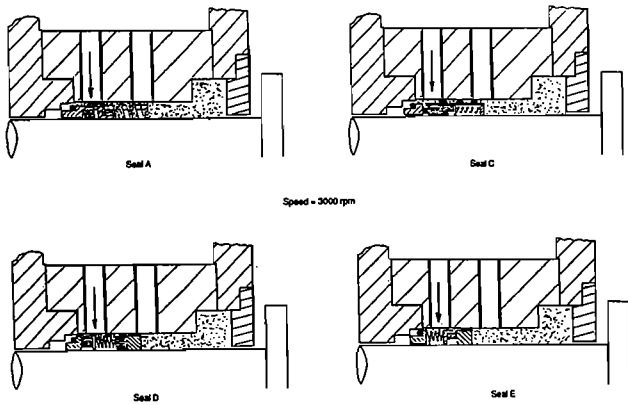

Figure 12. Narrow Parallel Housing. Seal-face flush, with bush, four seal types. Best narrow housing mode.



Figure 13. Narrow Parallel Housing. Sample photographs showing gas (white) concentrated in recesses and around springs.

Wide Parallel Housing

Strong turbulent vortex flow was a key feature of these housings (Figure 15). The speed at which the vortices first form is different for each housing, depending on the radial clearance, but vortices dominate the flow field even at the highest speeds. Consequently, gas removal from the recess at the seal face was generally good. Above about 2500 rpm, the chamber tended to take on a rather misty appearance, which a stroboscope reveals to be very small air

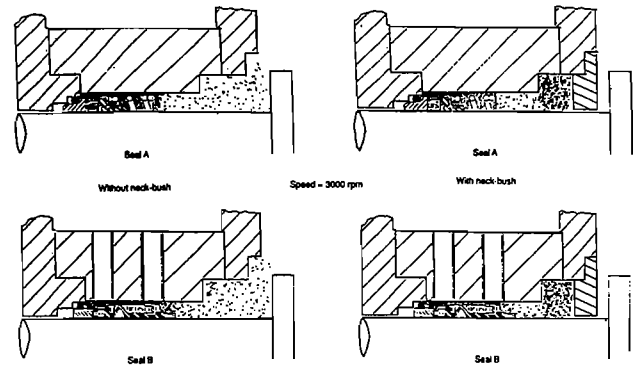

Figure 14. Narrow Parallel Housing. With/without bush, four seal types. Behavior of solids in suspension, note concentration near seal face.

bubbles in suspension. It is notable that, although gas is efficiently purged from the seal faces, it accumulates in large quantities at the impeller end of the seal chamber when a neck bush is fitted. Removal of the neck bush allows the air to vent into the impeller chamber. Flushing did not improve the already good gas purging ability of these housings.

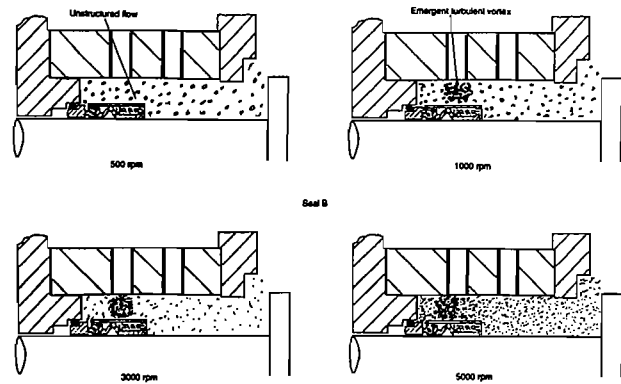

Figure 15. Wide Parallel Housing. Dead ended, shrouded bellows seal. Formation of strong local vortex as speed increases.

The strong vortex flow patterns exerted a major effect on coarse solids by drawing them into the vortex peripheries (Figure 16). This could be expected to cause serious local erosion. The addition

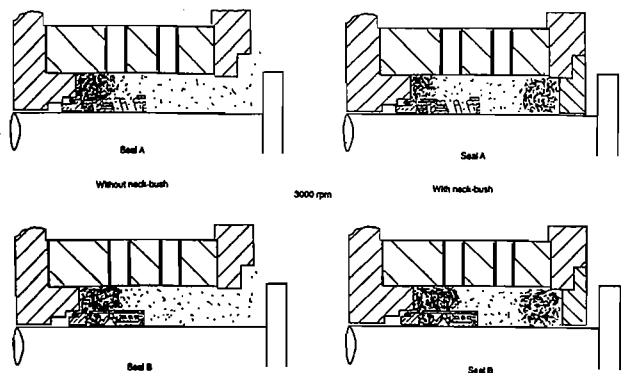

Figure 16. Wide Parallel Housing. Two seal types, with/without bush. Coarse solids orbit in periphery of vortices, with potential for local abrasive wear of chamber.

of axial strakes or “vortex breakers,” to modify the flow, dispersed the concentrations of solids but also caused some cavitation. The vortices were not eliminated but assumed a “corkscrew” shape. The strakes are, therefore, “vortex modifiers” rather than “vortex breakers.”

Fine solids appear to be insensitive to flow regime. Presumably, the mixing effect of the turbulence is sufficient to overcome the organizing effect of inertia forces. A local particle Reynolds number may perhaps be a useful parameter in this context, but has not been investigated.

Shallow Flared housing

A strong vortex system over the seal rotor was observed and gave efficient gas purging of the seal faces (Figure 17). The housing performed best when running without a neck bush but, as with the wide parallel housings, mistiness was noted at speeds in excess of 3000 rpm. The higher viscosity fluids tend to withdraw from around the seal faces unless there is an independent flush. The housing had no observable effect on fine solids, but appeared to cope with coarse solids, although not as well as the wide parallel housing with axial strakes.

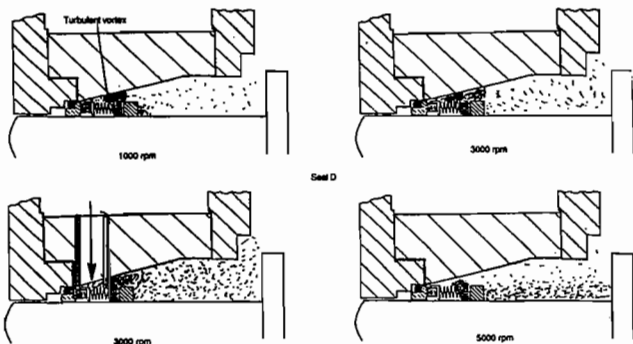

Figure 17. Shallow Flared Housing. Dead ended or with injection at seal face. Good gas/vapor purging close to seal face.

Steeply Flared Housing

The 45 degree flared housing was impressive in its gas purging abilities, irrespective of the seal design, piping plan or speed, and in many cases, was insensitive to the presence of a neck bush. (Figure 18). In general, most all traces of gas were rapidly removed, except at low speed (<1000 rpm) when gas lingered in the region behind the seal rotor. Like the other housings, fine solids were unaffected by the flow regime. Coarse solids tended to accumulate at the throat of the flare around the seal faces (Figure

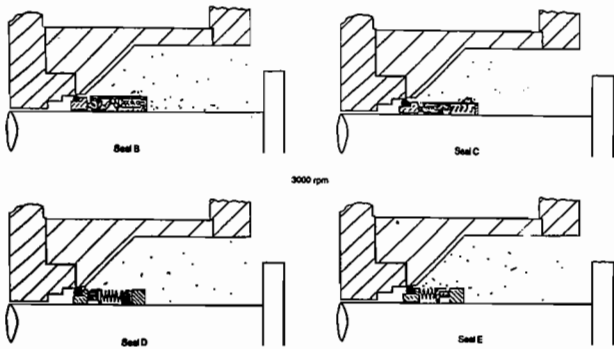

Figure 18. Steeply Flared Housing. Dead ended, four seal types. Efficient gas/vapor purging.

19), presumably the effect of an axial circulation from the impeller disc as the accumulations were reduced by the addition of a neck bush. No evidence of centrifuging of solids away from the seal was noted. The insertion of axial strakes helped to disperse the particles effectively, as for the wide parallel housing, but again gas handling ability is compromised.

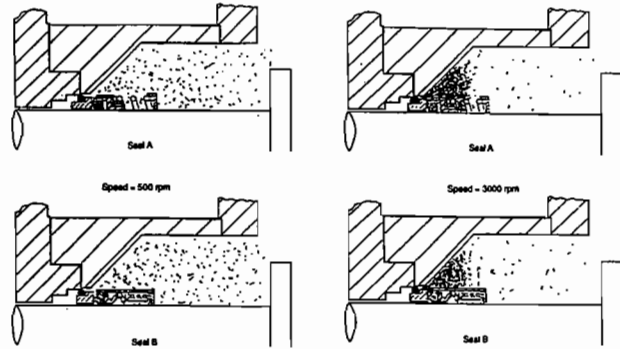

Figure 19. Steeply Flared Housing—Solids Behavior with Shrouded-Unshrouded Seals. Solids concentrate near seal face.

HEAT TRANSFER MEASUREMENTS

To calibrate the heat transfer probes the seal was placed in a laminar flow field, theoretical heat transfer coefficients for this being known.

Results of heat transfer tests are shown in Figure 20. A relationship between the convective heat transfer coefficient and peripheral Reynolds number is apparent. The best fit is given by:

$$h = 141 Re^{0.5} \quad , \text{ for } 1500 < Re < 600000 \quad (2)$$

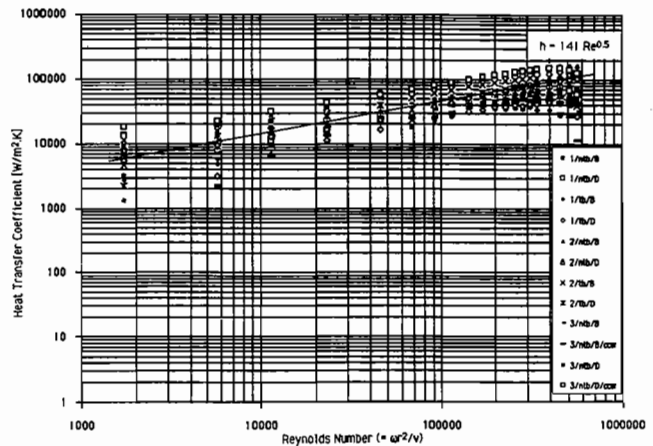

Figure 20. Effect of Reynolds Number on Heat Transfer. Key: 1) Narrow parallel housing; 2) Wide parallel housing; 3) Narrow parallel housing—tangential injection; tb. Neck bush; nb. No neck bush; B. Dead ended; D. Seal face inspection; ccw. counter-clockwise.

The results at low Reynolds number agree reasonably well with the theoretical value for laminar flow. Highly turbulent flow at high Reynolds numbers increases the heat transfer coefficient by an order of magnitude. The fall off at the highest Reynolds numbers was probably due to the slight, and unavoidable, rise in chamber temperature affecting the sensor output.

Compared with the literature for heat transfer around rotating smooth cylinders, the Reynolds number index agrees well but the constant of proportionality is higher in Equation (2). The differences are likely to be due to the secondary flows driven by radial surfaces of the seal and chamber. The present equation is likely to be more appropriate to real seal chambers.

The heat transfer results suggest that the radial clearance does not directly influence the heat transfer coefficient. This can be explained on the basis of the turbulent boundary layer around the seal rotor, with the high local shear rates therein driving the heat transfer from seal surface to bulk fluid. However, if poor housing design allows vapor or gas accumulations, then heat transfer from the seal can be seriously impaired.

CONCLUSIONS

Extensive flow visualization tests and novel heat transfer measurements have resulted in significant progress in understanding the factors controlling the functional behavior and optimization of mechanical seal chambers. This study has highlighted how control of the toroidal vortex flows can influence the transport processes vital for successful seal operation, despite such secondary inputs such as chamber end effects and seal external geometry.

Previously, heat transfer coefficients for mechanical seals were based on idealized long smooth cylinders. It is shown here that this does not predict actual heat transfer for seals in real chambers. Traditional narrow parallel chambers, defined or admitted by current standards, are consistently poor performers, especially in absence of independent flush. In particular, they are prone to gas, vapor or solids choking and, consequently, poor heat removal. In addition, the lack of radial space imposes undesirable structural design compromises on the seal manufacturer.

Performance in certain cases is affected by seal design and rotational direction. Enlarging the space around the seal to give a wide parallel housing considerably enhances performance at speeds of 3000 rpm or less, without the need for a flush, provided that a strong vortex regime is established. The radial clearance around the seal needs to be tailored to achieve this.

When large amounts of coarse solids are present, effective dispersion can be achieved by the inclusion of axial strakes or vortex modifiers.

The 45 degree flared housing enhances heat transfer and removal of gas, vapor, and solids, significantly improving performance relative to all other housing designs tested.

If it is recommended as the best current configuration for a seal chamber. This housing can often be operated dead-ended when other chambers require flushing. Axial vortex modifiers are again recommended when running with up to 10% of coarse solids, minimizing undesirable accumulations of solids at the seal faces and abrasive wall scour.

A systematic design implementation of these findings is given in the Housing Design Guide [19], now released by the project sponsors.

REFERENCES

1. Sangerhausen, C. R., "Proper Design Is First Step in Reducing Failures," *Oil & Gas Journal*, pp. 138-144 (Mar 23, 1981), pp. 169-178 (Mar 30, 1981).
2. Ingram, J. H., "Pump Specifications that Improve Mechanical Seal Performance," *Proceedings of the First International Pump Symposium*, Turbomachinery Laboratory, Department of Mechanical Engineering, Texas A&M University, pp. 123-129 (1984).

3. Bloch, H. P., "Mechanical Seals for Upgraded Medium-Duty Pumps," *International Sealing Conference*, pp. 1-13, (1986).
4. Heald, J. M., "The Seal's Environment—Its Housing," *BHRA 7th International Conference on Fluid Sealing*, Paper B4, pp. 17-24 (1975).
5. Bangert, P. "Slurry Transport" (BHRA translation), *Industrie-Anzeiger*, 91, p. 50 (1986).
6. Dosch, J. B., "Reducing ANSI Pump Maintenance Costs through Component Upgrades," *Proceedings of the Fourth International Pump Symposium*, pp. 9-17 (1987).
7. Heumann, A., "Shaft Seals on Centrifugal Pumps Handling Media with Suspended Solids, under Special Consideration of the Problems Associated with Flue-Gas Desulphurization," *International Sealing Conference*, Paper 10, pp. 1-15 (1986).
8. Schopplein, W. "Application of Mechanical Seals to Slurries with Particular Reference to Pumps and Agitators on Flue-Gas Desulphurization Plants," *Tribology International*, 19 (4), pp. 187-192 (1986).
9. Battilana, R. E., "Seal Housing Design Affects Seal Life in Pumping Slurries," *Pump Technical Library*, McGraw Edison Co., 20RP-2013 (undated).
10. Standish, D., "Planning a Pump Evolution," *Chartered Mechanical Engineer*, pp. 39-40 (March 1987).
11. Adams, W. and Van Hie, E., "Doubling the Life of Process Pump Seals," *Processing*, pp. 35-38 (December 1989).
12. Antkowiak, R., "Changes in Pump Design Can Reduce Seal Failures," *Chemical Engineering*, pp. 173-176 (May 1989).
13. Davison, M. P., "The Effects of Seal Chamber Design on Seal Performance," *Proceedings of the Sixth International Pump Users Symposium*, Turbomachinery Laboratory, Department of Mechanical Engineering, Texas A&M University, College Station, Texas, pp. 3-8 (1989).
14. Lymer, A. and Greenshields, A. L., "Thermal Aspects of Mechanical Seals," *Pumping Conference*, London (1965).
15. Taylor, G. I., "Stability of a Viscous Liquid Contained Between Two Rotating Cylinders," *Phil. Trans. Royal Society*, A233, pp. 289-343 (1923).
16. Gazley, C., "Heat-Transfer Characteristics of the Rotational and Axial Flow between Concentric Cylinders," *ASME Transactions*, 80, pp. 79-89 (1958).
17. Nau, B. S., "Rotary Mechanical Seals in Process Duties, an Assessment of the State-of-the-Art," *Proceedings, Institution of Mechanical Engineers*, 199, pp. 17-31 (1985).
18. Nau, B. S., "Research in Mechanical Seals," *Proceedings, Institution Mechanical Engineers*, 204, pp. 349-376 (1990).
19. Barnes, N D, Flitney, R. K., and Nau, B. S., *Mechanical Seal Housing Design Guide*, BHRG Report RR 3215 (1991).

ACKNOWLEDGEMENTS

The work reported herein was supported by the United Kingdom Department of Trade and the following companies: BP International, F. Burgmann & Sons, BW/IP International, Seals Div., Caltex (UK), John Crane Ltd., Durametall Corporation, EG & G Ltd., Sealol Division, Elf GB Ltd. (formerly Amoco (UK), Ltd.), ICI Plc, Lucas Aerospace Ltd, Morganite Special Carbons Ltd., Shell Expro, Turner & Newall Technology, Weir Pumps Ltd.