

IMPROVEMENTS IN BEARING LIFE USING NEW SEALING TECHNOLOGY

by

Chris Rehmann

General Manager, MagTecta Division

AESSEAL, Inc.

Knoxville, Tennessee



Chris Rehmann is General Manager of the MagTecta Division of AESSEAL, Inc., an international manufacturer of mechanical seals, in Knoxville, Tennessee. He has worked for Schlumberger, Ltd., in various engineering and management assignments in the USA, France, Egypt, Indonesia, Australia, and Saudi Arabia before joining AESSEAL.

Mr. Rehmann received his B.S. degree (Electrical Engineering, 1974) from the

University of Notre Dame.

ABSTRACT

As many as 91 percent of all rolling element bearings fail to achieve their calculated theoretical lifetimes. One of the primary reasons for this failure is contamination of the lubricants. Past practice for protecting bearings from contamination includes the use of lip seals and labyrinth isolators, but both of these solutions suffer from certain shortcomings that lead to premature bearing failures.

Using modern mechanical seal technology, it is now possible to hermetically seal pump bearing housings, gearboxes, and other rotating equipment, so as to completely contain the lubricant and totally exclude contaminants. With this hermetic seal in place, it is easier to cost-justify the use of superior (but more costly) synthetic lubricants, and lower the total cost of operating the equipment significantly.

THEORETICAL BEARING LIFE CALCULATION

The value of excluding lubrication oil contamination is best explained by first considering bearing life under ideal conditions.

The L_{10} life of a rolling bearing is defined as the number of revolutions (or operating hours) that the bearing is capable of enduring before the first sign of fatigue (flaking, spalling) occurs (SKF, 1999). The L_{10} life is the lifetime that 90 percent of a large group of identical bearings would be expected to achieve/exceed. The median life is five times the L_{10} life (i.e., 50 percent of the bearings would be expected to achieve/exceed a life that is 5× longer than L_{10}). The L_{10} life for a rolling element bearing is expressed as:

$$L_{10} = (C/P)^p \quad (1)$$

where:

L_{10} = Basic rating life, in millions of revolutions

C = Basic dynamic (theoretical) load rating

P = Equivalent dynamic (actual) bearing load

p = Exponent of the bearing equation

$p = 3$ for ball bearings

$p = 10/3$ for roller bearings

For bearings operating at a constant speed, it may be more convenient to express the lifetime, L_{10h} , in terms of operating hours, as follows:

$$L_{10h} = (1,000,000/60n)(C/P)^p \quad (2)$$

where:

L_{10h} = Basic rating life in operating hours

n = Rotational speed in rpm

REAL-WORLD BEARING LIFE

It is intuitively evident that real-world bearing life differs from the theoretical values above. Some authors (Bloch, 1998) have estimated that as many as 91 percent of all bearings fail to reach their calculated L_{10} life. For example, the published L_{10} life for a particular bearing in a pump is 55 years (Goulds, 2001). According to the above definitions, 90 percent of all those bearings should last longer than 55 years, and 50 percent of all those bearings should last longer than $5 \times 55 = 275$ years! Real-world lifetime experience for this bearing is usually not this long.

Why are the theoretical bearing lifetimes not observed in the real world? The answer is lubricant contamination! It is important to note that the above L_{10} lifetime calculations are based on *ideal operating conditions* of lubrication and temperature, using standard materials of construction, and for the generally accepted reliability factor of 90 percent. For other (nonideal) situations, the International Organization for Standardization (ISO) and the Anti-Friction Bearing Manufacturers Association (AFBMA) have introduced a revised life equation as follows:

$$L_{na} = a_1 * a_2 * a_3 (C/P)^p \quad (3)$$

or

$$L_{na} = a_1 * a_2 * a_3 * L_{10}$$

where:

L_{na} = Adjusted rating life, in millions of revolutions

a_1 = Life adjustment factor for reliability

a_2 = Life adjustment factor for materials

a_3 = Life adjustment factor for operating conditions

The index “n” in L_{na} represents the difference between the requisite reliability and 100 percent. For the generally accepted reliability of 90 percent and for bearing materials to which the C values correspond (standard steel), and for normal operating conditions,

$$a_1 = a_2 = a_3 = 1 \quad (4)$$

and the equations for the basic and the adjusted rating lives become identical. For most applications, we are interested in the lifetime calculation based on a reliability of 90 percent, so $a_1 = 1$. On the other hand, the values of a_2 and a_3 can change significantly, based on materials and *lubricant conditions*, and these changes have a large effect on the L_{10} lifetime calculation. Also note that the factors a_2 and a_3 are interdependent. For these reasons, bearing manufacturers have replaced them by a combined factor, a_{23} , in their life equations (SKF, 1999).

A detailed development of bearing lifetime calculation theory is beyond the scope of this paper, and the reader is referred to various

bearing manufacturers' catalogs. The important point here is that it is now possible to estimate mathematically the amount of bearing life improvement that will result from a given change in lubricant conditions. Weigand, et al. (1990), published a graph that describes the relationship between a_{23} and a viscosity term, v/v_1 , where:

v = Operating (actual) viscosity of the lubricant
 v_1 = Calculated (rated) viscosity of the lubricant

The effects on bearing life can now be graphically demonstrated from making a change in the lubricant cleanliness through the installation of dual-face magnetic seals. From the graph in Figure 1, it can be seen that by moving the operating point from point A (midrange of contaminated lubricant operation) to point B (midrange of clean lubricant operation), with no other change in the lubricating oil type or viscosity, it is possible to increase a_{23} from 0.2 to 0.7, or an increase of 3.5-fold. According to the above lifetime equations, this change will result in a bearing lifetime that is $3.5\times$ longer.

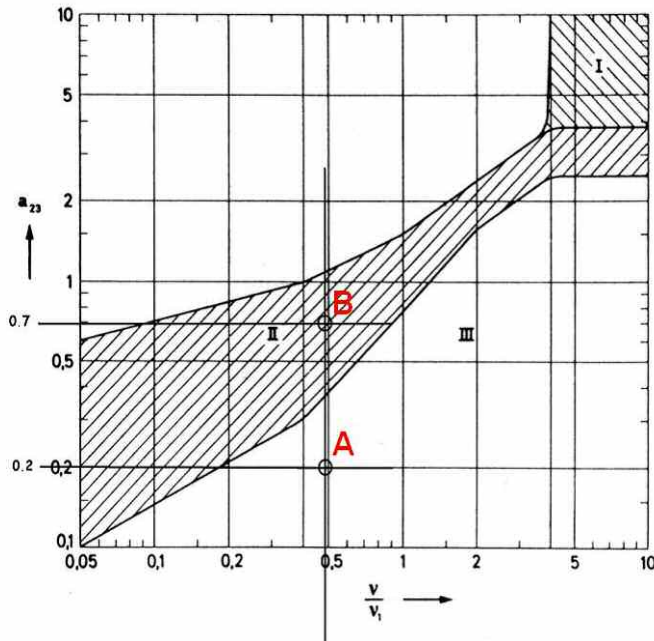

Figure 1. Life Adjustment Factor a_{23} Versus v/v_1 . (Zone I—Transition zone to unlimited life. Zone II—High degree of lubricant cleanliness. Zone III—Unfavorable operating.)

EFFECTS OF LUBRICANT CONTAMINATION

Many authors, technical societies, and companies have reported on the damaging effects that lubricant contamination has on the lifetime of rolling element bearings. Several comments from these authors are included below.

“Using worn lip or labyrinth-type bearing housing seals without paying attention to oil contamination has been shown to give plants typical bearing life expectancies of only about 2.5 years. With bearing replacements assumed to cost \$3,000 per pump, plants applying hermetically sealed housings can expect bearings to last an average of six years under identical operating conditions. For a petrochemical plant with 2,000 installed pumps, the value of avoided pump bearing failures exceeds \$1 million each year. Needless to say, the use of hermetic bearing housing sealing devices is eminently justified and should be advocated on an attrition basis. In other words, when oil-lubricated pumps go to the shop with bearing failures, they should be retrofitted with hermetic bearing housing seals” (Bloch, 1998).

Schatzberg and Felsen (1968), Cantley (1977), and others demonstrated that lubricant contamination with as little as 0.02 percent water (200 ppm, or 18 drops of water in 2 gallons of oil) in uninhibited lube oils can reduce bearing life by 48 percent (Figure 2). It is recognized that these tests were done using uninhibited oil, and modern inhibited oils would likely show a lesser life reduction. Nevertheless, the effects of small amounts of water contamination in bearing lubricating oil are readily apparent.

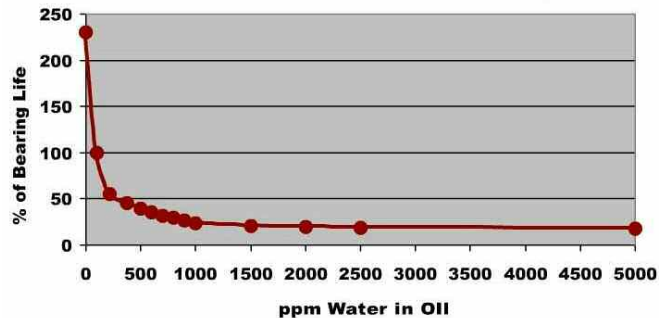

Figure 2. Decrease in Bearing Life with Increasing Water Contamination in Lubricating Oil.

The importance of *hermetically sealing the bearing housing* has long been recognized. “Hermetically sealing the bearing housing implies that *nothing* enters and nothing escapes. Only face-to-face sealing devices meet this definition” (Bloch, 2001). “Magnetic seals are the only practical hermetic bearing-housing closure. Hermetic sealing optimally extends the life of lubricants and bearings. Precluding lubricant contamination also makes the use of more expensive, but superior, synthesized hydrocarbon lubricants economically attractive” (Bloch, 2001).

The API 610 (2003) recommendation for centrifugal pumps is very clear on the important issue of lubricant contamination: “Bearing housings for rolling element bearings shall be designed to prevent contamination by moisture, dust and other foreign matter...Bearing housings shall be equipped with replaceable labyrinth-type or magnetic-type end seals and deflectors where the shaft passes through the housing.”

“Contaminated oil kills machines. Clean oil is one of the most important factors affecting the service life of the lubricated components of all machinery” (Whitefield, 1999). It is generally agreed by most authors that even very small amounts of contamination (water or particulates) do have a major, negative effect on the life of a rolling element bearing. So, what steps can be taken to isolate the bearings from this contamination? The next sections look at past and present bearing isolation systems, and their capabilities.

HISTORICAL BEARING ISOLATION METHODS

Lip Seals

Lip seals have been used to contain lubricants and exclude contaminants from bearings for over 60 years. While there are many variations now available, the design principle has changed little: a flexible elastomer forms a seal between a stationary member and a rotating member through pressure-contact with both members. A fluid film of lubricant is normally developed at the contacting interface, which helps to reduce friction and delay wear/damage to the contacting surfaces.

The design lifetime of most lip seals is 1000 to 3000 hours, which equates to only two to five months of continuous operation. This lifetime is under ideal operating conditions, which are rarely encountered. From the moment the lip seal is put into service, it begins wearing or fretting the shaft at the contacting periphery. Depending on the amount and quality of the lubricant, and the presence of outside contaminants, this fretting can quickly become serious, and may require that the shaft be replaced or resleeved when the lip seal is replaced (Figure 3). In any event, the lip seal must be replaced every 1000 to 3000 hours, as oil will begin leaking

out and contaminants will begin entering the bearings. The cost of this frequent change-out can be significant in terms of equipment and manpower required, as well as the value of lost production.



Figure 3. Fretting Damage on Shaft from Lip Seal.

In addition, lip seals are inherently one-way devices: they can hold the lubricant in if facing inward, or they can exclude contaminants if facing outward. A single lip seal in the normal, facing-inward, configuration offers little resistance to the entry of water from rain, pressure-washing equipment, nearby steam-quenched mechanical seals, etc. To seal in both directions, a double lip seal may be used, but in this configuration the outer lip is running dry, which will accelerate the lip wear and shaft fretting, and cause excessive heat buildup.

Stationary Labyrinths

Stationary labyrinths have been used to “seal” bearing housings on centrifugal compressors and API-style pumps for decades. “The most simple form of separate seal used outside the bearing is the gap-type seal that consists of a smooth gap at the exit of the shaft from the housing (Figure 4). This type of seal is adequate for machines in dry and dust-free surroundings. Where grease lubrication is used, the efficiency of this seal can be enhanced by machining one or more concentric grooves in the housing bore at the shaft exit (Figure 5). The grease emerging through the gap fills the grooves and helps to prevent the entry of contaminants” (SKF, 1999). The stationary labyrinth requires continual grease replenishment, and in any case does not provide a true seal.

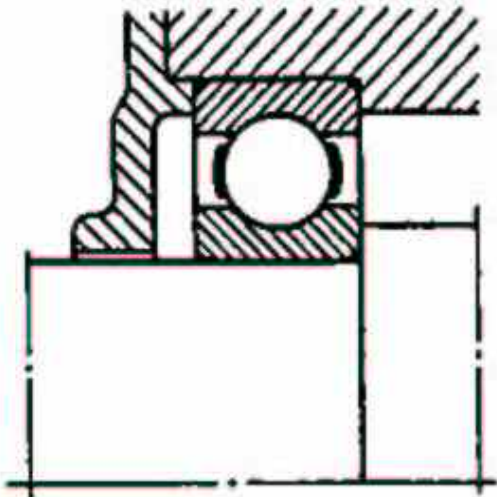

Figure 4. Early Stationary Gap-Type Labyrinth Isolator. (Courtesy SKF)

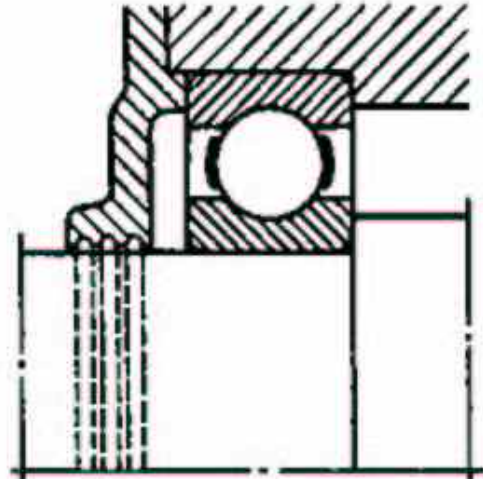

Figure 5. Improved Stationary (Grooved) Gap-Type Labyrinth Isolator. (Courtesy SKF)

Rotating Labyrinth

The rotating labyrinth was developed in the 1970s as the next generation of bearing isolators. This device employs a labyrinth, or tortuous path, which makes it more difficult for water, particles, and oil to pass through (Figures 6 and 7). Additional flingers and drain mechanisms were added over the years, to drain the escaping oil back into the oil reservoir, and the entering water back out of the unit. Since it has no contacting parts, the labyrinth isolator has a much longer lifetime than the lip seal. The rotating labyrinth seal has become the industry standard for protecting bearings on pumps, gearboxes, electric motors, and many other types of rotating equipment.

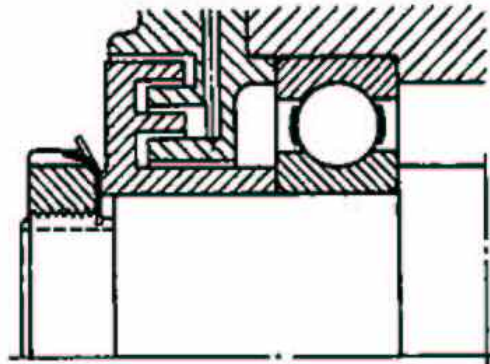

Figure 6. Rotating Labyrinth Isolator with Axial Tongues for One-Piece Housings. (Courtesy SKF)

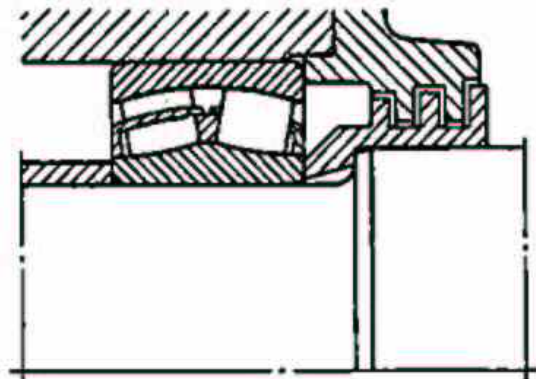

Figure 7. Rotating Labyrinth Isolator with Radial Tongues for Split Housings. (Courtesy SKF)

The primary drawback of labyrinth isolators is that they are not seals. They cannot exclude contaminants nor can they contain lubricants. They are completely ineffective on vertical shafts. Most importantly, they are affected by a phenomenon known as “breathing” (Figure 8). Breathing occurs as equipment heats up, and the oil and air mixture in the closed housing expands and escapes, typically via the labyrinth isolator. When the equipment is shut off it cools down, the oil and air mixture contract, and outside air is pulled into the housing, typically through the labyrinth isolator. The outside air that is drawn in often contains humidity, which will condense on the cool bearing components and initiate bearing failures due to corrosion and hydrogen embrittlement (Bloch, 1997).

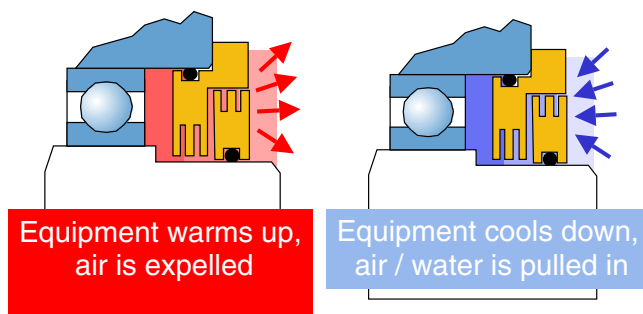

Figure 8. Chamber “Breathing” Through Labyrinth Isolators.

Compound Labyrinth

The compound labyrinth (“flying O-ring”) design was introduced in the 1990s to overcome this inherent drawback of simple labyrinths (Figure 9). According to the manufacturer, the flying O-ring is intended to lift off its seat due to centripetal force during operation, allowing the expanding air to pass out, but when the equipment is shut off it relaxes to its original position and forms a seal between the rotating and stationary members, thus preventing the entry of moist outside air. The manufacturer further claims that no wear is experienced by the O-ring during this operation.

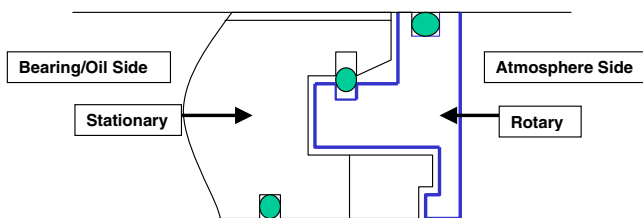

Figure 9. Compound Labyrinth Isolator with “Flying Elastomer.”

The validity of the flying O-ring theory has been questioned by several authors (e.g., Bloch, 2001). The Ideal Gas Law tells us that the hot oil and gases in a bearing housing will contract when the equipment is shut off and cools down. The flying O-ring is designed to seal and contain the partial vacuum created by this contraction. When the equipment is next restarted, the flying O-ring is designed to expand, which will allow outside air and contaminants to immediately enter the bearing housing. Furthermore, laboratory tests utilizing a water spray device have shown that this design will pass water and reach the 0.01 percent contamination level within 2.5 hours (Roddis, 2004). Most serious analysts agree that the flying O-ring cannot continually make and break contact between rotating and stationary members without undergoing wear and ultimately losing its sealing ability. The research by Roddis (2004) showed that the flying O-ring does indeed wear significantly. Nevertheless, the compound labyrinth has represented “best available technology” for bearing isolation for several years.

CURRENT BEARING SEALING TECHNOLOGY

Single-face, magnetically-energized bearing seals have been available for aerospace applications since the 1950s. They have made major inroads in process industry sealing applications for about the last 12 years. These seals typically utilize a 400-series stainless-steel face, which is magnetically attracted and pressed against a Teflon® face, thus providing the first hermetic bearing seal (Figure 10).

ITEM	DESCRIPTION	MATERIAL
1	ROTARY SEAL CASE	BRONZE
2	MAGNETS	RARE EARTH
3	O-RING	VITON
4	ROTARY INSERT	COMPOSITE
5	STATIONARY FACE	IG24K
6	HOUSING ADAPTOR	STAINLESS STEEL
7	O-RING	VITON

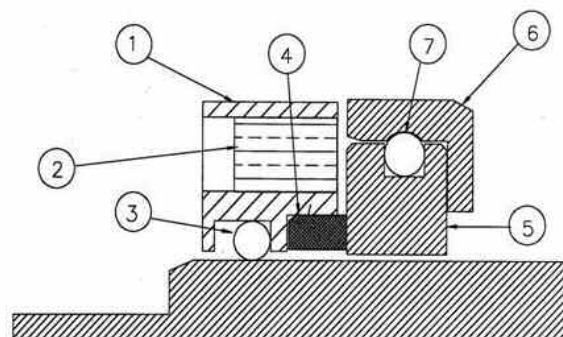

Figure 10. Single-Face Magnetic Isolator.

These single magnetic seals have proven very popular in overcoming many of the deficiencies of lip seals and labyrinth isolators, and are used extensively in the refinery and petrochemical industries. End-users were pleased with the improvements from this seal design, but have suggested the following areas where the single magnetic seal could be improved:

- Magnets are exposed and made of corrosion-susceptible metal, leading to corroded magnets that swell and lift the faces apart.
- Graphite-impregnated Teflon® face is soft, wears quickly.
- Teflon® face is also not suitable for high-temperature operations; loses flatness.
- Single-face design can be pushed open with pressure-washing equipment.

STATE-OF-THE-ART BEARING SEALING TECHNOLOGY

A new *double-face, magnetically-energized bearing seal* has recently been introduced, which overcomes all of the above shortcomings. The magnets are nickel-plated to avoid corrosion. The faces are made of antimony-carbon and tungsten carbide (TC), which are proven, tough mechanical seal face materials. The double-face design is such that if one face is blown or pushed open, the other face is simultaneously pressed closed by an equal amount (Figure 11).

HIGHER SPEEDS AND/OR LARGER SHAFT SIZES

On higher-speed and/or larger-diameter shafts, heat generation from the outboard (nonlubricated) face of the first double-face magnetic seals led to the introduction of a second-generation seal design that replaces the outboard carbon face with bronze-filled Teflon® (BFT), while retaining the carbon/TC face on the inboard side. With the improved coefficient of friction on the outboard side, this design can operate in an oil-splashed environment at surface velocities up to 20 m/sec (Figure 12).

1. Tungsten Carbide Rotary
2. O-ring
3. Antimony Carbon Stationary
4. O-ring
5. Stainless Steel Housing
6. O-ring
7. Phosphor Bronze Spacer
8. Magnet, Samarium-Cobalt
10. O-ring
11. Retainer Clip
12. 416 Stainless Steel Holder

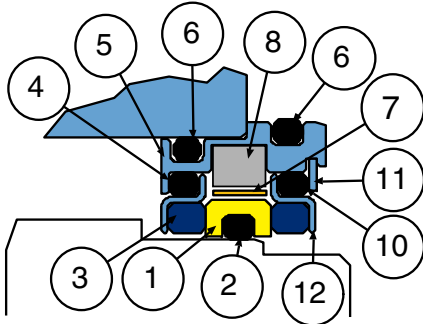

Figure 11. Dual-Face Magnetic Isolator. (Courtesy AESSEAL, Inc.)

1. Tungsten Carbide Rotary
2. O-ring
3. Antimony-Carbon Stationary
4. O-ring
5. Stainless steel housing
6. O-ring
7. Phosphor-bronze spacer
8. Magnet, Samarium-Cobalt
9. Bronze-filled Teflon Stationary
11. Retainer Clip

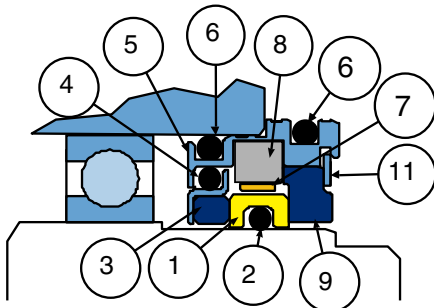

Figure 12. Dual-Face Magnetic Isolator for API and High-Speed Applications. (Courtesy AESSEAL, Inc.)

LARGE AXIAL MOVEMENTS

One of the greatest challenges for a reliability engineer is to seal rotating equipment in which the shaft makes significant axial movement during operation. This movement may be the result of thermal growth, as in a steam turbine, or it may be caused by the thrust from helical gears in a gearbox. In either case, the close tolerances of a labyrinth seal preclude the use of this type of isolator, as the rotary and stationary portions of the labyrinth could touch and damage each other. Historically, engineers have chosen lip seals for this duty, despite the shortcomings of lip seals listed above.

A specially-designed dual-face magnetic seal has been developed to accommodate up to ± 0.100 inch (2.5 mm) of axial movement, by using a semidynamic O-ring as shown in Figure 13. This design has been successfully implemented at several sites, including a phosphate mine in Florida on large slurry pumps that have shaft movement of 0.046 inch on startup. Another successful field installation was made at a California refinery on a gearbox with 0.050 inch axial shaft movement.

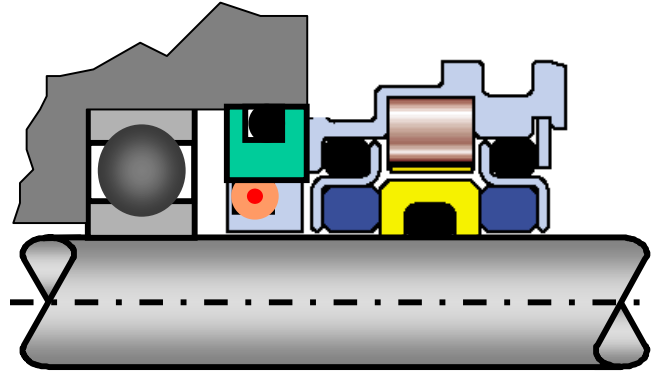

Figure 13. Dual-Face Magnetic Isolator for Applications with Large Axial Movement. (Courtesy AESSEAL, Inc.)

TESTING RESULTS OF NEW MAGNETIC SEAL

Leakage Test Results

Laboratory tests by Alan Roddis (2004) compared water leakage from a dual-face magnetic seal to a compound labyrinth isolator with flying O-ring. Identical tests were run at 1800 rpm, with high-velocity (13 m/sec) water spray directed at the isolators, to simulate a "worst-case scenario" where an adjacent leaking mechanical seal could spray water directly in the direction of the bearings. A photograph of the test setup is shown in Figure 14.

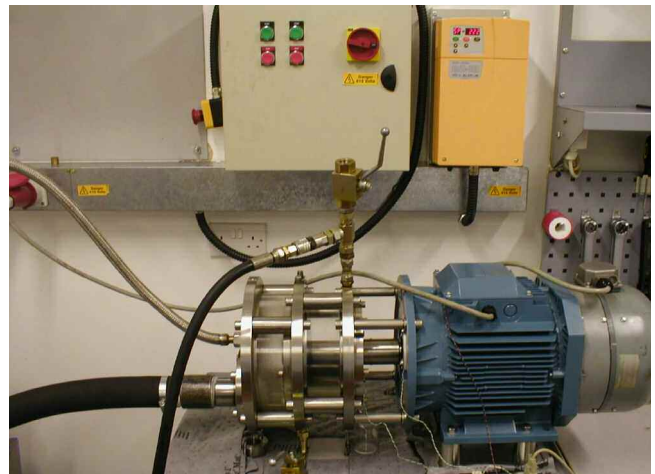

Figure 14. Test Rig for Bearing Isolator Leakage Testing. (Courtesy AESSEAL, Inc.)

The water-spray leakage test by Roddis indicated that 0.01 percent water contamination level in the lubricating oil (for the test oil volume of 650 ml of oil) was reached in the following time periods:

- Dual-face magnetic seal—500 hours
- Compound labyrinth isolator with flying O-ring—2.5 hours

In addition to the above leakage results, the tests allowed for an insight into the dynamics of the flying O-ring design of the

compound labyrinth isolator. Photographs of the flying O-ring before (Figure 15) and after (Figure 16) running at 1800 rpm for 15 minutes indicate that wear damage has already begun. It is obvious that the surface finish of the O-ring has degraded, resulting in the loss of sealing performance. This result supports the conclusion that “scraping and galling wear modes are noted on circumferentially contacting dynamic O-rings (such modes are why O-ring manufacturers do not recommend high-cycle dynamic, circumferential sealing applications).” (Bloch and Geitner, 1997; National O-Ring Co.).

Before...



Figure 15. New Dynamic O-Ring from Compound Labyrinth Isolator.

After...

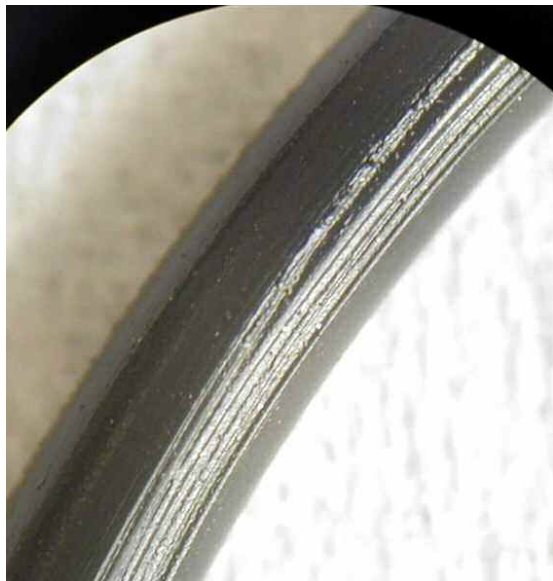

Figure 16. Dynamic O-Ring Run for 15 Minutes on Compound Labyrinth Isolator.

In summary, Roddis’ results indicate that the double-face magnetic seal may be 200 times more effective than the compound labyrinth isolator at excluding water spray from a bearing housing.

Magnet Properties

Until recently, neodymium magnets represented the best available technology for single-face magnetic isolators. The new dual-face magnetic isolators utilize nickel-plated samarium-cobalt magnets, which cost more but which have a higher temperature rating and higher thermal stability than neodymium, as shown in Table 1.

Table 1. Technology Comparison for Magnetic Isolators.

Magnet Type	Corrosion-Resistant?	Temperature Rating
Neodymium-Iron-Boron	No	100-200°C (210 - 420°F)
Samarium-Cobalt	Yes	250°C (480°F)

Temperature Considerations

One significant difference between a face-type magnetic isolator and a labyrinth isolator is that the contacting faces experience friction, which produces heat. A noncontacting labyrinth produces essentially zero heat. For this reason, the dual-face magnetic isolators were extensively tested at different shaft sizes, rpm, and ambient temperatures to determine the maximum temperature rise for the purpose of ATEX (1996) rating. Tests were run both with marginal lubrication and with no lubrication. The results of the testing are shown in the composite curve in Figure 17. This graph shows that the latest dual-face magnetic isolators may be run at shaft surface speeds up to 20 m/sec (3900 fpm) without exceeding the ATEX (1996) “T6” temperature rating of 85°C, under marginal lubrication conditions. This speed limit corresponds to a 4.25 inch shaft operating at 3600 rpm, or an 8.50 inch shaft at 1800 rpm. The dual-face magnetic isolators therefore meet the most stringent European temperature-safety regulations for use in explosive atmospheres.

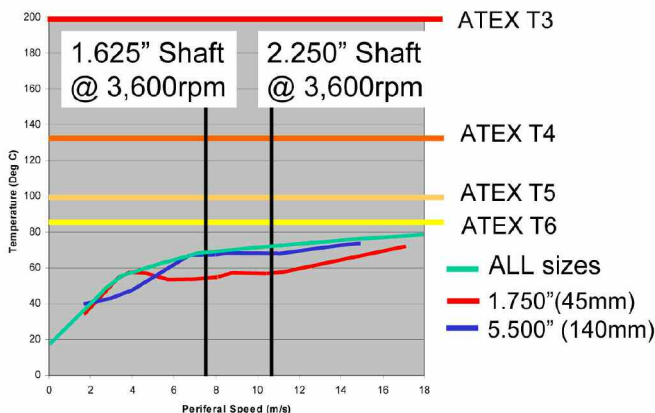

Figure 17. Temperature Versus Peripheral Shaft Speed Curves for Magnetic Bearing Isolator. (Courtesy AESSEAL, Inc.)

Safety Testing and Rating

The carbon/TC/carbon magnetic seal shown in Figure 11, and the carbon/TC/BFT magnetic seal shown in Figure 12, have been extensively studied and practically tested under worst-case scenarios by an independent laboratory in the United Kingdom, for both electrostatic and electromagnetic spark generation potential, to ensure safe operation in hazardous areas. Both seals also comply with API 610, Ninth Edition (2003), guidelines. The seal shown in Figure 12 is listed as ATEX-certified to T6 rating (maximum surface temperature <85°C or 200°F) for use in potentially explosive atmospheres, or more specifically, rated to ATEX (1996) II 2 GD c T6. The dual-faced magnetic seal may be the only modern bearing isolator that has been so extensively tested for safety compliance.

COST EFFECTIVENESS AND FIELD EXPERIENCE

Return on Investment Case #1—Generic ROI

Rather than focusing on only the additional expense of a new piece of equipment, reliability engineers often look at the total cost of ownership via a return on investment (ROI) calculation. The ROI calculation determines how long it will take (breakeven point) for the savings from the new equipment to pay for itself. A “typical” ROI calculation table and graph are shown in Table 2 and Figure 18. In this example, a lip seal (cost: \$10) that is leaking oil at a rate of one quart per week and that has a lifetime of one year, is replaced by a dual-face magnetic seal (cost: \$200, leakage: zero) with a lifetime of five years. In both cases, the shaft sleeve and bearings are replaced when the seals are replaced.

Table 2. Case #1—Generic ROI Example, Input Data and Results.

INPUT VALUES			
	Lip Seal	Mag Seal	
Cost of Seal	\$ 10.00	\$ 200.00	US\$
Labor Rate	25	25	US\$/hour
Lost Oil Cost	3	3	US\$/qt
Amount Oil Lost	4	0	qts/month
Time Between Sleeve Replacements	12	NA	months
Sleeve Cost	200	NA	US\$
Bearing Cost	150	150	US\$
Equipment Repair Time	8	8	hours
Expected Life	12	60	months

RETURN ON INVESTMENT (ROI) RESULTS			
	Lip Seal	Mag Seal	
Cost of Seal	10	40	US\$/year
Equipment Repair Cost	550	70	US\$/year
Lost Oil Cost	144	0	US\$/year
TOTAL	704	110	US\$/year
Breakeven Point:		117 days	
Savings After Breakeven:		\$594/year	

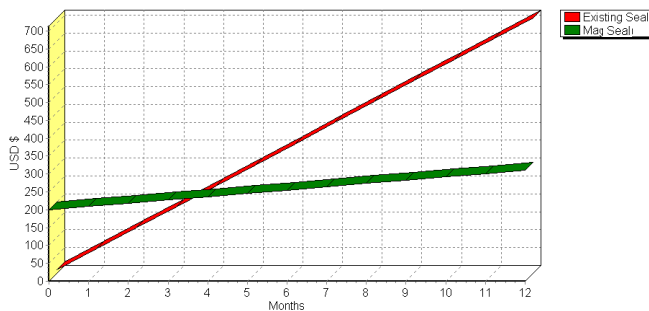

Figure 18. Case #1—Generic ROI Example, Graph Showing Breakeven Point under Four Months.

At first glance, it seems impossible to cost-justify the replacement of a \$10 lip seal with a \$200 dual-face magnetic seal, no matter how much better the latter seal works. However, the ROI calculation takes into consideration the very real additional costs due to frequent repairs and lost lubricants with the lip seal, and compares the total cost of ownership of each seal in graphical form. Note that the breakeven point in Figure 18 is only four months. After this point, the equipment owner begins saving \$600 per year by using the magnetic seal. The equipment owner often

experiences additional savings due to less frequent process interruptions (lost production). These savings can be considerable in high-volume, high-value operations such as refineries.

Return on Investment Case #2—Refinery Fire Savings

One major Gulf Coast refinery estimates that one out of every 1000 pump bearing failure events results in a \$6,000,000 fire. A typical refinery may experience such a fire every two years (\$3,000,000 per year). After implementing hermetic sealing at an incremental cost of \$600,000 (2,000 pumps × \$150 per seal × 2 seals per pump), such fires may take place only once every four years (\$1,500,000 per year). In this case, the imputed value of reduced fire-related incidents would amount to \$1,500,000 per year, and the payback period would be less than five months from these savings alone. The above numbers may be modified for each refinery’s particular experience level, but the basic concept of imputed value and payback period remains the same.

Return on Investment Case #3—Large Slurry Pump Example

This is a real-life ROI example, where leaking lip seals on several large slurry pumps at a mining operation in the Southeastern USA were replaced by dual-face magnetic seals. The mean time between failures (MTBF) for the slurry pumps was only six months with lip seals, due to continual bearing failures. These large pumps cost an average of \$8000 each (total cost for labor, parts, cranes, etc.) per repair. The dual-face magnetic seals for this 4-7/16 inch shaft cost \$933/each, versus \$150/each for the lip seals (each pump required two seals). Initially, the end-user balked at the large difference in the cost of the seals (\$1866 versus \$300 per pump). However, the large initial investment for magnetic seals was more than offset by the greatly reduced number of pump repairs. The ROI calculation and graph are shown in Table 3 and Figure 19. Despite the large difference in the initial prices, the total cost of ownership of the lip seals is actually 9× that of magnetic seals. The breakeven point is only 34 days, and after breakeven, the savings to the equipment owner due to the use of magnetic seals is \$16,727 per year. After reviewing the ROI calculations using his own numbers, the end-user has begun installing dual-face magnetic seals on this, and several other, larger pumps throughout the mining operation.

Table 3. Case #3—ROI Example on Large Slurry Pump, Input Data and Results.

INPUT VALUES			
	Lip Seal	Mag Seal	
Cost of Seal	300	1866	US\$
Labor Rate	20	20	US\$/hour
Lost Oil Cost	10	10	US\$/qt
Amount Oil Lost	10	0	qts/month
Total Cost to Rebuild Bearing Frame	8,000	8,000	US\$
Equipment Repair Time	25	25	hours
Expected Life	6	60	months

RETURN ON INVESTMENT (ROI) RESULTS			
	Lip Seal	Mag Seal	
Cost of Seal	600	373.2	US\$/year
Rebuilding Cost	17,000	1,700	US\$/year
Lost Oil Cost	1,200	0	US\$/year
TOTAL	18,800	2,073	US\$/year
Breakeven Point:		34 days	
Savings after Breakeven:		\$16,727/yr.	

Case History #1

A paper mill in Alabama owns 12 sump pumps from a major API pump manufacturer. These pumps occasionally run dry, as do most

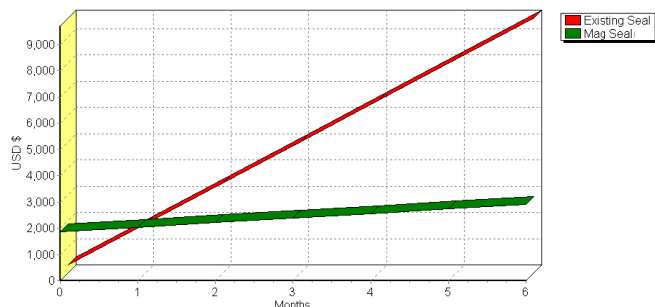

Figure 19. Case #3—ROI Example on Large Slurry Pump, Graph Showing Breakeven Point Less Than One Month.

sump pumps. The dry-running causes the pump's mechanical seal to fail, and water floods the bearing housing. Previously, the bearings were protected by lip seals, which could not seal out the water when the box pressure was applied. MTBF for the pumps with lip seals was about two months, and the cost to repair the pump bearings was about \$2000.

The lip seals were replaced by dual-face magnetic seals (shaft: 1.750 inch diameter at 1800 rpm) on both ends of the pump (Figure 20). The pumps still run dry and damage the mechanical seals, but when they do, the dual-face magnetic seals protect the bearings. Nine of the 12 pumps have been converted so far, and *no bearing failures have occurred since the first magnetic seal was installed 13 months ago*. The paper mill estimates it has *saved over \$40,000* during this period by converting to the dual-face magnetic seals.



Figure 20. Dual-Face Magnetic Isolator Installed on Bearing Frame of Sump Pump. (Courtesy DanHart Inc.)

Case History #2

A large newsprint mill in the Pacific Northwest uses gearboxes (shaft speed: 130 mm at 1200 rpm) on their de-inking machines. The bearings were protected by lip seals, which normally began leaking within six months. The lip seals wore grooves in the shaft, causing further leakage and requiring frequent shaft repair/replacement. The oil leakage (about one drop per minute) was collected in a bucket (Figure 21) under the leak, which caused workplace safety concerns. The oil level in the gearbox required constant checking and topping-up.

A dual-face magnetic seal was installed in place of the lip seal during the last gearbox overhaul. The oil leaking stopped immediately. The shaft damage was eliminated. The danger of low oil in the reservoir, the cost of the lost oil, and the manpower required for manual checking and topping-up was eliminated. Personnel safety and good housekeeping have been improved. In this case, the benefits to the equipment owner are both financial (cost of lost oil, cost of frequent repairs, etc.) and health-related (safety, housekeeping).



Figure 21. Gearbox at a Newsprint Mill, Leaking Oil Prior to Installation of Magnetic Bearing Isolator. (Courtesy Industrial Packing Company)

Case History #3

A major pulp and paper mill in the Pacific Northwest uses large pumps to move stock from the digester to the wash plant. The mill has used packing shaft seals and labyrinth bearing isolators on these pumps for about 15 years. During normal maintenance, the millwrights adjust the impeller shaft to compensate for impeller wear, which results in the labyrinth isolator separating. The pumps often cavitate, due to changing process conditions. The resulting vibration from the cavitation causes the packing to leak stock. The leaking stock and wash-down water pass through the open labyrinth isolators directly into the bearing housing, resulting in pumps/bearings failing and being rebuilt about twice a year.

Dual-face magnetic seals were installed on the radial side (3.25 inch \times 4.25 inch) and the axial side (2.375 inch \times 3.375 inch) of the pump. The process has been through the cavitation and vibration conditions several times. The packing has leaked stock and the wash-down hoses have drenched the bearing housing. The millwrights have adjusted the impeller. The lubricating oil shows no sign of water contamination, and has needed zero replenishment. This mill estimates that the pump run time will be increased from six months to two years or more, due to the dual-face magnetic seals.

CONCLUSIONS

- Total (hermetic) sealing of bearings and bearing housings is essential to achieving optimum lifetimes from rotating equipment.
- Old-style bearing sealing technologies (lip seals, labyrinth isolators) were good.
- Single-face magnetic seals are better than lip seals and labyrinth isolators.
- New state-of-the-art dual-face bearing seals using mechanical face-seal technology are the best available technology for hermetic sealing bearings and housings.
- Synthetic oil, which is a superior but more expensive lubricant, can be more readily cost-justified with the use of dual-face magnetic seals, since oil leakage and contaminant entry are eliminated.
- Whether using synthetic or natural mineral oil, significant savings are realized from the use of magnetic face seals due to reduced oil consumption/losses, reduced labor costs to check and top-up fluids, reduced frequency of drain-and-fill operations due to water contamination, and reduced oil disposal costs.

- Dual-face magnetic seals have a lower total operating cost than lip seals and labyrinth isolators, as shown by ROI calculations. Payback periods for recovering an investment in magnetic seals may be as short as a few months.
- Equipment owners experience less down time, less machine damage, and significant financial savings with magnetic face seals as compared to lip seals and labyrinth seals.
- Since hermetic sealing of the bearing housing prevents the escape of any lubricant liquid or mist to the environment, dual-face magnetic seals assist equipment owners to voluntarily achieve compliance with both the spirit and the letter of environmental regulations.
- Imputed savings from reduced fire-related costs due to the use of dual-face magnetic isolators can result in payback periods of as short as six months at a typical refinery. After the payback period, significant savings accrue to the refinery's bottom line.

REFERENCES

- API Standard 610, 2003, "Centrifugal Pumps for Petroleum, Petrochemical and Natural Gas Industry," Ninth Edition, American Petroleum Institute, Washington, D.C., 5.10.2.7 and 5.10.2.9.
- ATEX, 1996, *The Equipment and Protective Systems Intended for Use in Potentially Explosive Atmospheres Regulations 1996*, Norwich, United Kingdom: Her Majesty's Stationery Office.
- Bloch, H. P., 1998, *Improving Machinery Reliability*, Volume 1, Third Edition, Houston, Texas: Gulf Publishing Company, ISBN 0-88415-661-3.
- Bloch, H. P., October 2001, "Bearing Protection Devices and Equipment Reliability," *Pumps & Systems*.
- Bloch, H. P. and Geitner, F., 1997, *Machinery Failure Analysis and Troubleshooting*, Houston, Texas: Gulf Publishing Company, ISBN 0-88415-662-1.
- Cantley, R. E., 1977, "The Effect of Water in Lubricating Oil on Bearing Fatigue Life," *ASLE Transactions*, 20, (3).
- Goulds® 3196 Technical Data Catalog, 2001, 725.1A400, page 15.
- National O-Ring Company® General Catalog, Engineering Section.
- Roddis, A., 2004, "21st Century Bearing Protectors," Presented to United Kingdom Society of Mechanical Engineers, Rotherham, Yorkshire, United Kingdom.
- Schatzberg, P. and Felsen, I. M., 1968, "Effects of Water and Oxygen During Rolling Contact Lubrication," *Wear*, 12, pp. 331-342.
- SKF® General Catalog 4000, 1999, Third Edition.
- Weigand, K., Eschmann, P., and Hasbargen, L., 1990, *Ball & Roller Bearings: Theory, Design & Application*, New York, New York: John Wiley & Sons Publishing Company, ISBN 0-471-26283-8.
- Whitefield, D., 1999, "Clean Up Your Oil—Revisited," 4001 *ORBIT*, Fourth Quarter.