

COMMISSIONING AND START-UPS OF NEW UNITS (PUMPS)

by

Wallace E. (Ed) Wilcox

Staff Machinery Engineer

Chevron Energy Technology Company

Houston, Texas

Mike White

Field Service Manager

and

Gordon Parks

Senior Field Engineer

Sulzer Pumps (US) Inc.

Portland, Oregon



Wallace E. (Ed) Wilcox is a Staff Machinery Engineer with Chevron Energy Technology Company, in Houston, Texas. He worked for more than 10 years with Conoco and Citgo as a Rotating Equipment Engineer, and he has authored papers on vibration analysis and performance testing.

Mr. Wilcox has a BSME degree from the University of Missouri Rolla, and an MSME degree from Oklahoma State University. He has also done postgraduate work at the Georgia Institute of Technology in the areas of lubrication, rotordynamics, and vibration. He is a Vibration Institute Level 111 Vibration Specialist and a registered Professional Engineer in the State of Oklahoma.



Mike White is the Manager of Field Services for Sulzer Pumps (US) Inc., in Portland, Oregon. He is responsible for the startup of new equipment—pumps, drivers, supporting systems. He supervises and trains the startup group for Sulzer. Mr. White has worked for 35 years at Sulzer Pumps, in manufacturing, pump assembly, service center, nuclear seals, and field services departments.



Gordon Parks is a Senior Field Engineer for Sulzer Pumps (US) Inc., in Portland, Oregon. He has more than 30 years of experience with Sulzer Pumps and has worked as a Field Services Representative, Field Service Manager, Service Center Manager (in USA and Asia) and Resident Engineer at a refinery.

Mr. Parks has a BSc degree from Portland State University.

ABSTRACT

Installation and startup of centrifugal pumps and drives can be a stressful time. It involves a coordinated working relationship with several crafts—foundation contractors, pipefitters, welders, millwrights, startup engineers, electricians, and information

technology (IT) technicians. Also the startup routine is the last event in the long process from ordering equipment to installation. By the nature of being last in the process, any delays in the upstream processes are expected to be mitigated by a quick uncomplicated startup. With these pressures in place a firm dedication to following procedures is required. The steps from installation to startup are described and in their proper sequential order.

INTRODUCTION

An example of startup events not in proper order is the case of the pump mounted on the base, but not centered on the base hold down holes in the pedestals. The driver is then rough aligned to the pump and signed off. Next the piping is made up to the pump. It is noticed at this time that the pump is “bolt bound.” As this is an unacceptable condition, the piping is released, the pump is centered, the driver realigned to the pump, and the piping is realigned to the pump nozzle flanges sometimes resulting in cutting and welding of these large bore pipes. All the extra work is time consuming and costly, not to mention the toll it takes on morale in having to do the job again. Figure 1 shows the proper sequence of events for the first part of the process—foundation, leveling, grouting. Figure 8 likewise shows the ordered sequence of steps that occur after the base is set, and grout cured. The steps shown are an overview in order to emphasize the overall order of the process. A more detailed explanation of these events can be found in API 686 (1996).

INSTALLATION SEQUENCE CHECKLIST

Processing Unit _____
Equipment Tag No. _____

EVENT

- Foundation Construction
- Prepare Foundation
- Clean Underside of Baseplate
- Set Baseplate over Foundation Bolts
- Level Baseplate using Jack Screws & Leveling Pads
- Snug-up Foundation Anchor Bolts
- Check Leveling of Baseplate
- Mount Driver (if Field Mounted)
- Check for Soft Feet, Pump and Driver
- Rough Align Driver to Pump
- Grout Baseplate
- Final Torque Foundation Bolts after Grout Cures
- Install Main Piping
- Check for Pipe Strain
- Final Alignment
- Fill System

Check off when satisfactorily completed

Figure 1. Foundation/Grouting Checklist.

FOUNDATION CONSTRUCTION

The method shown in Figure 2 can be used to determine whether a pump foundation is sized adequately.

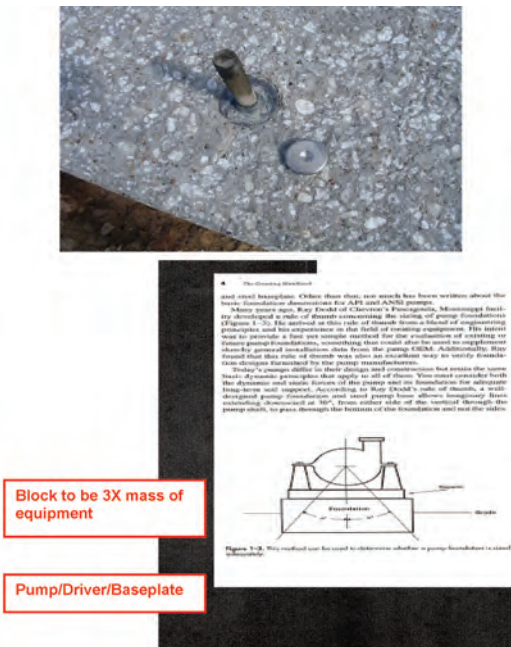

Figure 2. Top Surface Foundation and Foundation Area to Mass Ratio Diagram.

PREPARE FOUNDATION



Figure 3. Surface to Be Rough Chipped and Clean.

CLEAN UNDERSIDE OF BASEPLATE

Cleanliness is essential (Figure 4). The bottom of the base should be painted with epoxy grout primer if required.



Figure 4. Under Side of Base Plate.

SET BASEPLATE OVER FOUNDATION BOLTS

The base is equipped with anchor bolt holes (Figure 5), leveling holes, 5 in (127 mm) grout holes, and 0.5 in (12.7 mm) air holes.



Figure 5. Location of Anchor Bolts on Side Rails of Base Plate.

LEVEL BASEPLATE USING JACK SCREWS AND LEVELING PADS

The leveling jackscrew is reacting on a stainless steel button that will be grouted in permanently (Figure 6). For this reason the top surface is rounded to prevent point loading leading to stress risers in the grout.



Figure 6. Anchor Bolts and Leveling Jackscrew.

The overhang of the base pad allows leveling of the pads without removal of the pump (Figure 7). Today both removal of the pump and leaving it in place are acceptable. Traditionally all the machines were removed from the base for leveling. Due to costs and complexity of auxiliary attachments it is desirable to leave the equipment in place.



Figure 7. Overhang of Base Pad.

☑ SNUG-UP FOUNDATION ANCHOR BOLT NUTS



Figure 8. Base Plate Tightening after Base Level on Pads Achieved.

☑ CHECK LEVELING OF BASEPLATE

This step is to ensure that during the prior step of snugging the anchor bolts, the base level has not changed (Figure 9). Requirements for level are 0.002 in/ft (0.17 mm/m). Each foot must be level to themselves and the other feet within 0.002 in (0.05 mm).

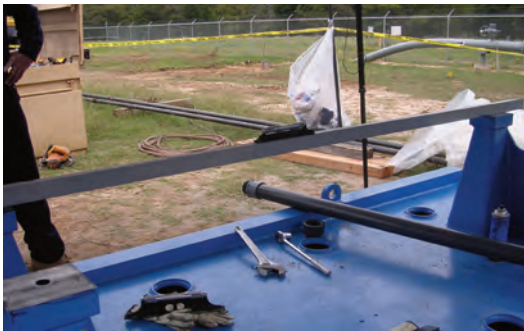

Figure 9. Base with Straightedge and Machinist Level.

☑ MOUNT DRIVER (IF FIELD MOUNTED)

Many times the motor is delivered to the field directly which means the mounting process normally done at the factory is done in the field (Figure 10). In this situation the motor is set on the motor pads. The coupling alignment including the distance between shaft ends (DBSE) is made. After completion, a scribe is used to scratch the circular outline of the Hold down bolt on the base pad. This is done by reaching into the motor hold down holes and scribing the base pads using the holes as a guide. Lift the motor off, then drill and tap the base pads. The motor can then be repositioned on the base.



Figure 10. Base with Motor Mounted in the Field, not in the Factory.

☑ CHECK FOR SOFT FEET, PUMP AND DRIVER

First ensure all the hold down bolts are tightened. They do not have to be torqued. Soft feet are discovered by setting up a magnetic base to the pump/motor pedestal. The dial is attached with the button on

the top of the foot (Figure 11). The hold down bolt is then loosened. If a soft foot exists the foot will raise up. The amount is read on the dial indicator. The maximum 0.002 inches (0.05 mm) is allowed.



Figure 11. Pump Feet with Dial Indicator.

☑ ALIGN DRIVER TO PUMP

This alignment (Figure 12) is to ensure that coupling alignment can be made prior to grouting of the base. Should there be problems in achieving alignment there the base may have to be reworked. Once grouted, options are severely limited. First the machines are centered in the hold down holes. Side to side alignment is made. Vertical alignment is not made at this time. It is important to note however that the driver is lower by approximately 0.130 inches (330 cm). It is standard practice to shim the driver and leave the pump feet free of shims. The lower driver pads ensure this is the case.



Figure 12. Rough Alignment.

Bases are provided with sufficient number of grout holes 4 or 5 inch in diameter, to allow the grout to access all areas (Figure 13). Note the small vent holes on the perimeter of the base.

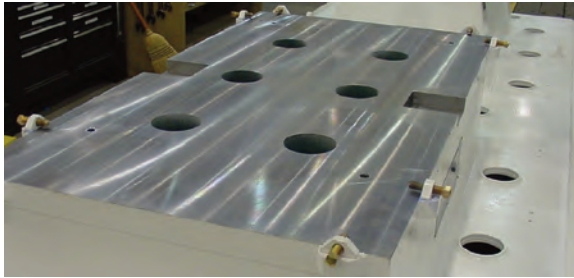

Figure 13. Base with Grout Holes Through Motor Pad.

Voids are detected using a hammer on the deck plate. The most critical areas to be concerned about are under the pedestals. These are also the hardest places to get the grout to flow to. Drill and tap the deck plate to match the threads on a high pressure gun (grease gun). Epoxy grout can then be pushed into voids. Trapped air is discharged through air holes in the deck plate. Additional holes may have to be provided.

GROUT BASEPLATE

It is now time to grout the base (Figure 14).



Figure 14. Grouting.

FINAL TORQUE FOUNDATION BOLTS AFTER GROUT CURES

A practice seen more and more is to use cementitious grout in the bottom of the base and finish off with epoxy grout (Figure 15). There are grouting handbooks available that go into the specifics of this process. One point to be made here is the need to allow epoxy grout to cool sufficiently. Epoxy grout is done in three pours allowing for cooling of each pour. This minimizes the risk of the heating causing distortion to the fabricated base.



Figure 15. Initial Grout Pour.

Once the grouting has cured—a matter of days—the equipment if removed from the base is returned. Rough alignment is made.

EXAMPLE OF IMPROPER GROUT APPLICATION

Figure 16 is an example of a foundation cracked. It may be due to water freezing heaving up the concrete. This photo also shows there is no grouting under the sole plate or anchor bolts present.



Figure 16. Discharge Head Vertical Pump.

INSTALL MAIN PIPING

The main piping is now attached to the pump (Figure 17).



Figure 17. Main Piping.

CHECK FOR PIPE STRAIN

Once the fitters have welded up the main piping, it should be rechecked for excessive strain on the pump nozzles (Figure 18). Note the stanchion welded to the base is not good practice. Piping supports should not be on the base and clear of the foundation.



Figure 18. Check for Pipe Strain.

☑ FINAL ALIGNMENT

Coupling alignment guidelines are shown in Figure 19. Always ensure the machines are centered in the hold down holes and the “air gap” (DBSE) is proper before finishing the final alignment. Many times one or both of these items is left out, which causes this process to be repeated.

- Alignment methods: dial indicator, reverse align, laser align.
- What is acceptable?
- Flexible couplings.
- Thermal growth.
- Majority of pumps are centerline mounted.
- Motors generally set .002 low.
- Thermal growth offsets supplied by equipment manufacturer (gears and fluid drives).
- Gears have vertical, horizontal and axial offsets. Fluid drives have vertical and axial only.

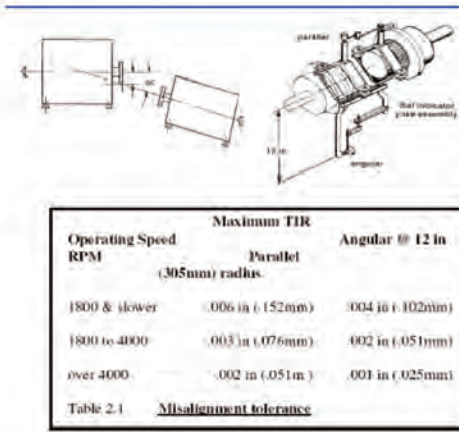

Figure 19. Coupling Alignment Guidelines.

☑ FINAL ALIGNMENT—THERMAL OFFSETS

- Power pumps and API pumps are typically centerline design machines where the pump foot is at or near the shaft horizontal centerline. Vertical thermal growth is minimal.
- Motors are foot mounted and frame temperature soak from the shaft centerline relates to vertical thermal offset.
- Fixed gears have more complex coupling alignment offset requirements. Again, significant growth is vertical due to thermal soak in the frame. Additionally there is a thermal growth that occurs side to side.
- There is a mechanical offset requirement also due to the action of the pinion gear moving up on the bull gear. All these offsets in gears can be obtained from the gear manufacturers. It is normally found on the mass elastic diagram.
- Steam turbines being hot and foot mounted also have significant vertical offset requirements—more than motors.
- Gas turbines have vertical offsets and many times have an angularity offset in the vertical plane. This is due to the fact that the hot engine portion is in the back and the much cooler compressor section is near the drive-end. The coupling will end up “open” at the bottom.

Figure 20 is an example of how thermal offsets are communicated today. Note the DBSE/DBCFF are set up to accommodate axial growth. The preset amount is the coupling spacer length plus the thermal growth distance. When the machines are running and at temperature, the shafts have grown closer together providing the exact coupling center member is fit into the DBSE.

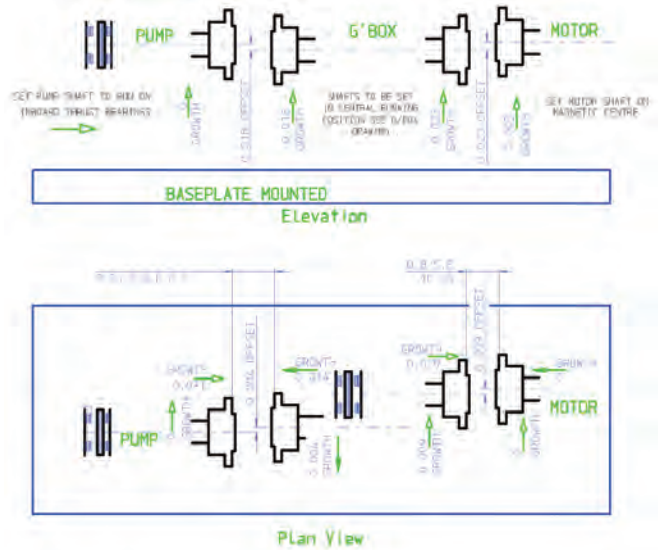

Figure 20. Thermal Offset Map as Supplied by OEM.

☑ FILL SYSTEM

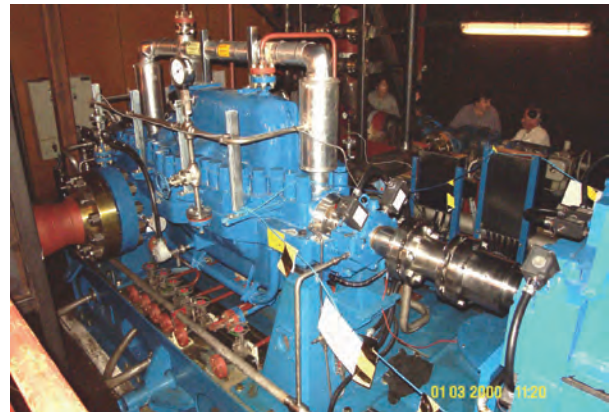

Figure 21. Pump Flooded with Product.

PRE STARTUP CHECKLIST

A pre startup checklist is shown in Figure 22.

- Leveling and Grouting of Base
- Check Train for Soft Feet
- Strainer in Suction
- Minimum Flow Orifice
- Warm-up Orifice
- Suction Gauge
- Discharge Gauge
- Pipe Strain
- Bearings Removed and Cleaned
- Check Bearing Clearance with Plastigauge (if rated operating speed is over 4000 RPM)
- Check Coupling Hub Runout (pump and motor)
- Lube System Flushed
- Oil Level Checked and Pressure Switches Set
- Distance Between Shafts _____
- Rotation and No Load of Drive has been Checked
- Hot Service - Set Aligning Blocks. Remove .002 Shim & Torque Outboard Pump Hold down Bolts to Torque Value
- Final or "Hot" Alignment in Accordance With IOM

Figure 22. Field Service Rep Checklist.

The following explains the steps in detail.

- ☑ Leveling and Grouting of Base
- ☑ Check Train for Soft Feet (Figure 23)

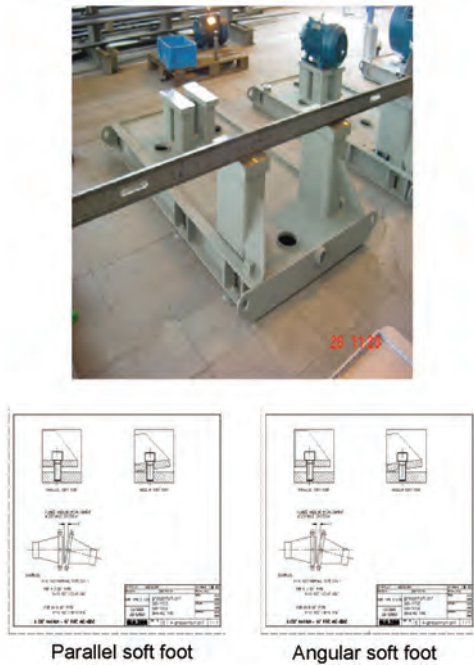

Figure 23. Checking for Soft Feet.

- Check pump and motor pads for flatness, etc.
- Soft foot creates 1x frequency vibration.
- Base level is always spoken of relative to the machined pads, not deck plate.
- Deck plate is sloped for drainage and is not a precision surface.
- Check pads with the use of a precision straightedge, machinist level, and shim stock.
- Optical transit equipment can also be used.

Strainer in Suction

- Figure 24 is a startup strainer.
- Typical screen is #8 mesh (0.063 wire with 0.125 spaces between).
- Stops large objects from entering pump. Not intended to be a fine filter
- If required as part of the process, a permanent, more elaborate filtering product should be installed.

Ex Monitor the pressure drop across the suction strainer. An increased pressure drop across the strainer of 5 PSI (34.5 kPa) indicates that the strainer be removed and cleaned. After a period of time (24 hours minimum) system flushing should be complete and the suction strainer can be removed.

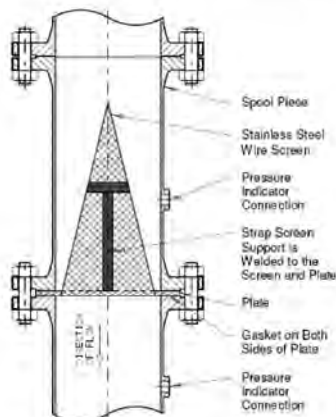

Figure 24. Suction Strainer.

- Minimum Flow Orifice
- Warm-up Orifice

A minimum flow diagram is shown in Figure 25.

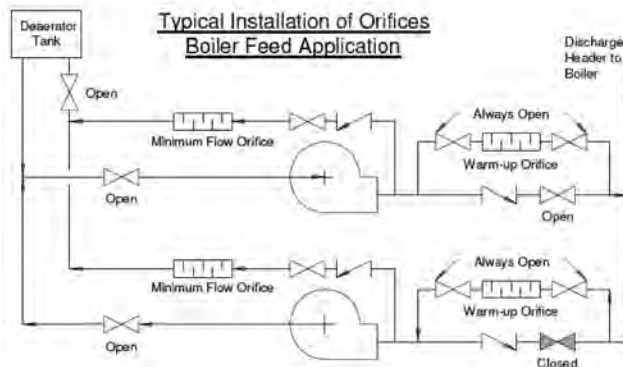

Figure 25. Minimum Flow Diagram.

All pumps need protection should the application the pump is in have low demand periods. The requirement for a minimum flow line is not universal. Some applications do not need this protection. An example would be flood water, injection service where demand is steady or the pump is turned off.

- Suction Gauge
- Discharge Gauge
- Pipe Strain

Pump nozzle loads are shown in Figure 26.

Flange angular misalignment acceptance criteria

EXAMPLES:
 X = (0.002) (Nominal pipe dia.)
 for a 2.00" pipe
 X = (0.002") (2) = 0.004"
 for an 8.00" pipe
 X = (0.002") (8) = 0.016"
 0.030" maximum - 16" pipe and above

- Checking pipe strain.
- 2 dial indicators on pump shaft.
- Vertical and horizontal plane.
- Maximum pump movement .002 measured on the shaft extension

MAXIMUM ALLOWABLE NOZZLE LOADS					
	FORCE IN LBS.				
	F ₁	F ₂	F ₃	F ₄	F ₅
8" SUCTION	560	365	480	1010	
4" DISCHARGE	320	400	250	570	
MOMENTS IN FT LBS.					
	M ₁	M ₂	M ₃	M ₄	M ₅
8" SUCTION	1700	870	1300	2410	
4" DISCHARGE	860	670	240	1300	

Approx. Bolt Hole Deviation

Figure 26. Pump Nozzle Loads.

The pump manufacturers provide allowable moments and forces on the suction/discharge nozzles. The values are to ensure proper operation should loads suddenly be applied, or to handle "cold" loads that dissipate after startup due to thermal changes. It is inappropriate to allow unnecessary loading due to these allowable levels.

- Bearings Removed and Cleaned
- Check Bearing Clearance with Plastigauge (if rated operating speed is over 4000 RPM)
- Check Coupling Hub Runout (pump and motor)

A bearing assembly nondrive-end is shown in Figure 27.

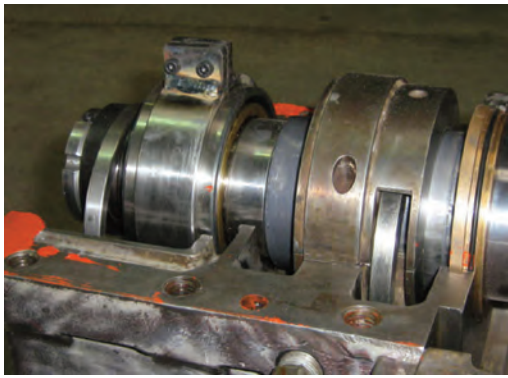

Figure 27. Bearing Assembly NDE.

Cleaning of bearings is almost always required. It depends on the length of time between manufacture and startup, and the environmental conditions around the pump during this period of time. The startup group should always at least disassemble a representative bearing to make sure there is no water, corrosion, or particulate matter present.

- Lube System Flushed
- Oil Level Checked and Pressure Switches Set

A lube oil system is shown in Figure 28. Heating of the oil is required to help in the cleaning process. The immersion heater is used to heat up the reservoir. Another method is to run hot product through the cooling side of the heat exchanger.



- Initial flushing must bypass all bearing housings.
- Primarily sleeve/kingsbury.
- Oil circulating/anti-friction.

Technician:	
User:	
Project:	
Customer PO No.:	
Service:	
Site:	
Plant Tag No.:	
Pump OEM:	
Station Index Order No.:	

Lube Oil System Flushing Procedure

1. All bearing housing are to be jacked and set to get the best velocity flush possible. Oil in the reservoir should be heated to 100–130 degrees Fahrenheit.
 2. One hundred mesh screens to be installed in all bearing housing drain lines to lube oil reservoir.
 3. Inspection of screens will take place four hours after start of initial flushing of system and less frequently as system cleans up.
 4. Light tapping of the piping with a hammer will help clean up the system.
 5. During flushing of lube oil system, remove the pump bearings for inspection.
 6. After system has cleaned up, remove all jumper lines around bearing housings, leaving in the one hundred mesh screens installed in pump bearing housings drain lines to the lube oil reservoir.
 7. Then flush through pump bearing housings, less the pump bearings for 1 hour.
 8. After the system has cleaned up, then install the pump bearings with clean one hundred mesh screens in place.
 9. Then flush system for 1/2 hour.
 10. Shut down lube oil system and remove the one hundred mesh screens from lube oil main header drain lines to reservoir with customer as witness.
- Customer Witness: _____ Date: _____
11. Drain lube oil reservoir, remove the one used lube oil filter.
 12. Hand clean lube oil reservoir and filter body.
 13. Add new oil to reservoir and install new lube oil filter.
 14. System is ready for operation.
- Safety Service Rep. Signature: _____ Date: _____

Figure 28. Lube Oil System..

- Distance Between Shafts
- Rotation and No Load of Drive have been Checked

The coupling spacer or an inside micrometer is used to set the DBSE (Figure 29). This should be set as close as possible plus or minus 0.010 in (0.25 mm).

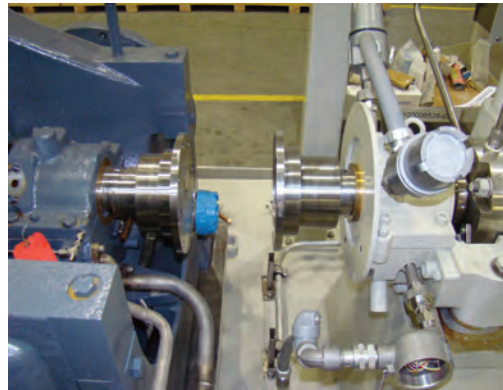
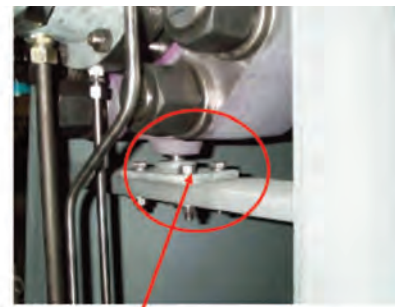
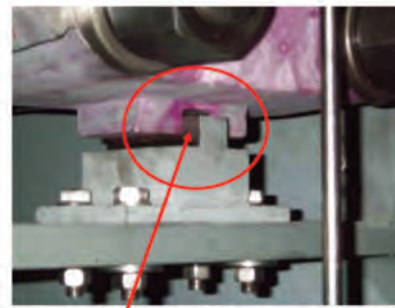

Figure 29. DBSE—Distance Between Shaft Ends.

- Hot Service—Set Aligning Blocks (Figures 30 and 31).
- Remove .002 Shim and Torque Outboard Pump Hold Down Bolts to Torque Value
- Final or “Hot” Alignment in Accordance with IOM



To accommodate axial growth due to high temperature operation the suction end of the barrel is equipped with a pin which fixes the Drive End of the pump.



The discharge end is equipped with a key slot which will allow the barrel to expand in the direction of the NDE end. The barrel to pedestal bolts are torqued to a specific value to accommodate the axial growth

Figure 30. Hot Alignment Keys and Blocks Barrel Pump.

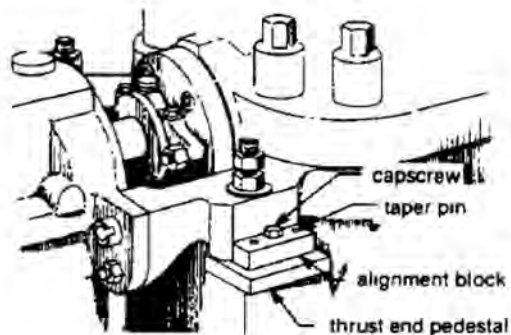

Figure 31. Hot Alignment Blocks Horizontal Split Pump.

Multistage horizontal pumps grow thermally along the shaft axis. The drive-end is pinned to lock in the coupling alignment. A guide key arrangement is used on the nondrive-end to allow the pump to expand and contract due to the operating temperatures. Typically these features are only used on pumps 250°F or higher.

Figure 32 shows a startup checklist and Figure 33 shows a pump prepared for first start.

- Open Suction Valve
- Vent Pump or Warm-up Pump Case if Required
- Check Gland Setting if Packing Fitted
- Purge Seal Flush Lines
- Hook-up Seal Gland Bushing Flush
- Close Vent Valves
- Set Discharge Valve
- Suction Pressure at Start-up _____
- Discharge Pressure at Start-up _____
- Dowel Only after "Hot" Alignment
- Check the Lube and Cooling System to see that the Temperature Stabilizes
- Check Vibration Inboard Max. _____ Outboard Max. _____
- Check off when satisfactorily completed

Figure 32. Startup Checklist.



Figure 33. Pump Prepared for First Start.

Contaminants can gather under the mechanical seal gland bushing due to the area being open to atmosphere. This bushing runs a close running clearance—0.025 in (0.64 mm) diametrical to the seal sleeve. In normal operation this clearance is not lubricated and if clean and centered presents no problem. After sitting the clearance can become dirty. Always flush the bushing using the pipe taps on the seal gland at the 10 o'clock or 2 o'clock position prior to startup. Keep a small stream of water going under the bushing during initial startup. This lubricates and cools the bushing preventing a "pick-up" and seizure that can gall the seal sleeve. Worse, with enough heat the shaft will bend. After a short time, about 30 minutes of running time, the water can be shut off.

New systems have to be completely vented. In one instance a 10-stage pump was started up and ran well for a few minutes. The suction line was very long, 1000 ft to a storage tank. Unknown was a large air pocket half way. When it reached the pump, the pump continued to operate but the discharge gauge once steady began swinging. The air pocket filled the first stage impeller creating a dry run situation. On touch the pump case was burning hot. Fortunately the steam turbine service rep standing by understood the situation and immediately turned off the turbine salvaging the pump from seizure.

FINAL PRE STARTUP CHECKS

- Walk through the startup sequence with the operators.
- Witness flooding and venting of the pump and seals.
- Verify:

- Oil pressures (lube oil system, LOS) and flows through the bearings.
- No leaks are present on lube oil and seal piping.
- Proper warmup of the pump (hot service).
- By hand that pump turns freely.

OPERATIONAL CHECKS

- Record suction and discharge pressures.
- Monitor and record bearing temperatures (housing and with handheld gun).
- Check temperatures on seal inlet and outlet lines.
- Monitor suction differential pressure on suction screen (if equipped).
- Take vibration readings.
- Monitor lube oil reservoir temperatures.

When obtaining operating data, ensure there is no leakage undetected through the minimum flow line or another main line that is supposed to be blocked off. Undetected flows correspond to a pump that seems to be low in performance when taking data. Verifying pump performance is shown in Figure 34, and checking vibration is shown in Figure 35.

RELATING FIELD PERFORMANCE TO CURVE

$$\text{Operating Pump Head} = \frac{(\text{Disch Press} - \text{Suction Press}) \text{ psig} \times 2.31}{\text{S.G.}}$$

$$\text{Operating Pump Head} = \frac{(142 - 50) \text{ psig} \times 2.31}{0.78}$$

$$\text{Operating Pump Head} = \frac{92 \times 2.31}{0.78} = 272 \text{ feet}$$

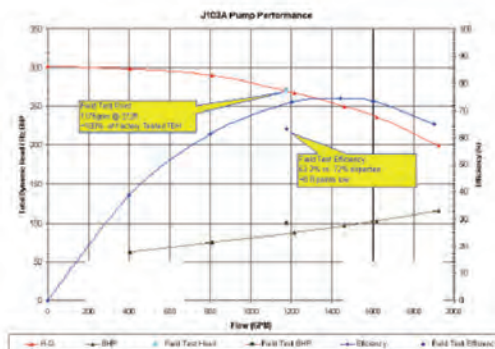

Figure 34. Verifying Pump Performance.

API 610 10TH EDITION

Bearing Housings Amplitudes:

0.08 [in/sec] RMS filtered
0.12 [in/sec] RMS overall

(+30% vibration increase outside preferred operating range

Shaft Amplitudes:

1.5 mils peak-peak at 3600 RPM

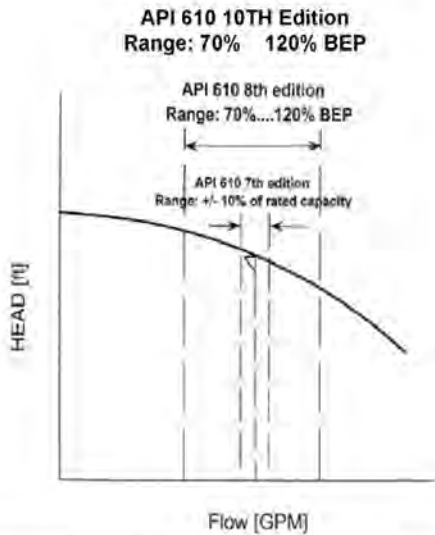

	Key frequencies (most common)
1 x	Out of balance; misalignment
2 x	Misalignment
VP	Vane Pass (# of vanes x pump speed)

Figure 35. Checking Vibration.

POST STARTUP MEETING

- Identify outstanding actions or issues.
- Discuss maintenance of equipment.
- Spare part strategy
- Local service shops
- IOM up-to-date

CONCLUSION

The end product from the commissioning and startup of pumping systems determines the health of the system for years. It is therefore important to allocate the proper amount of time and resources to it. Care and thoroughness should be the watch words for successful completion.

REFERENCES

API Standard 686, 1996, "Machinery Installation and Installation Design," American Petroleum Institute, Washington, D.C.

BIBLIOGRAPHY

Harrison, D. M., 2000, *The Grouting Handbook: A Step-by-Step Guide to Heavy Equipment Grouting*, Gulf Professional Publishing.